

# TOSHIBA



# OWNER'S MANUAL

## DLP™ Projection Television



**62CM9UA**  
**62CM9UE**  
**72CM9UA**  
**72CM9UE**

### Owner's Record

You will find the model number and serial number on the back of the TV. Record these numbers in the spaces provided below. Refer to them whenever you call upon your TOSHIBA dealer regarding this product.

Model number:

Serial number:

Introduction

Getting started

Using the TV's features

Viewing teletext

Equipment connections

Reference section

## Welcome to Toshiba

- Thank you for purchasing this Toshiba DLP™ Projection Television. This manual will help you use the exciting features of your new TV.
- Instructions in this manual are based on using the remote control.
- You can also use the controls on the TV if they have the same name as those on the remote control.
- Please read all the safety and operating instructions carefully, and keep the manual for future reference.

## Contents

### Introduction

Important Safety Instructions .....	3
Installation .....	3
Use .....	5
Service .....	6
Cleaning .....	7
Important information .....	8
Important information .....	8

### Getting started

Installation .....	9
Connecting an antenna .....	9
Installing the remote control batteries .....	9
Exploring your new TV .....	10
TV right side .....	10
TV front .....	10
TV back .....	11
Learning about the remote control .....	12
Location of controls .....	12
Turning the TV on .....	13
Switching on the TV .....	13
Switching off the TV .....	13
Learning about the menu system .....	14
Menu display chart .....	14
Selecting a language .....	15
Programming channel memory .....	16
System selection, Auto tuning .....	16
Manual tuning .....	16
Program sorting .....	18
Watching TV programs .....	19
Volume, Sound mute, Changing program positions, Program return, On-screen information .....	19

### Using the TV's features

Viewing the wide-screen picture format .....	20
Picture size selection .....	20
Picture position, Reset .....	21
Picture position adjustment .....	21
Reset (Picture position adjustment) .....	21
Picture quality adjustment .....	22
Picture quality adjustment .....	22
To activate the black stretch .....	23
To activate the MPEG NR (Noise Reduction) ... ..	23
To activate the DNR (Digital Noise Reduction) .....	23
To select the color temperature .....	24
To use the cinema mode .....	24
Selecting the lamp mode .....	25

Sound adjustment .....	26
MTS (Multi-channel TV Sound) setting .....	26
Selecting the Dual 1 or Dual 2 mode .....	26
Stereo/Bilingual selection .....	27
Sound quality adjustment .....	27
To select the audio output .....	28
To select the HDMI audio mode .....	28
To use the WOW surround sound .....	29
To use the stable sound .....	29
To activate/deactivate the speaker .....	29
Woofers Internal/External mode, Bass boost, Woofer system .....	30
Input source selection .....	31
Input source selection .....	31
Timer, Blue screen, Auto format .....	32
Timer .....	32
To activate Blue screen .....	32
To use the Auto format .....	32
Side panel adjustment, Quick restart .....	33
Side panel adjustment .....	33
Setting the Quick restart feature .....	33

### Viewing teletext

Teletext – Setting up .....	34
Teletext mode .....	34
About Teletext .....	35
Teletext general information .....	35
Teletext SW adjustment .....	35
Teletext – FAST and LIST modes .....	36
Using FAST mode .....	36
Using LIST mode .....	36
Teletext – Control buttons .....	37
Teletext buttons on the remote control .....	37

### Equipment connections

Side connections .....	38
Connection example .....	38
Back connections .....	39
Connection example .....	39
Connecting a computer (PC) .....	40
To connect a computer .....	40
PC setting .....	41
To adjust a PC setting .....	41
Connecting an HDMI and a DVI device .....	43
To connect an HDMI and a DVI device .....	43

### Reference section

Troubleshooting .....	44
Symptom and solution .....	44
LED indications .....	45
Lamp unit replacement .....	46
Replacing the lamp unit .....	46
How to replace the lamp unit .....	47
Broadcast system, Specifications .....	48
Broadcast transmission systems of each country or region .....	48
Specifications .....	48

# Important Safety Instructions

- See "Important notes about your DLP™ projection TV" on page 8.
- Be sure to observe the following instructions and precautions to ensure safe use of this TV.

## Installation

**Always connect the power plug to an electrical outlet equipped with 220 – 240V AC 50 Hz.**

Never use the TV outside the specified voltage range. It may cause a fire or an electric shock.

**WARNING ABOUT THREE-WIRE GROUNDING-TYPE PLUG:**

Never remove the earthing pin on the power plug. This system is equipped with a three pin earthing-type power plug. This plug will only fit an earthing-type power outlet. This is a safety feature. If you are unable to insert the plug into the outlet, contact an electrician to replace the wall outlet.

Never defeat the purpose of the earthing plug.

Check!

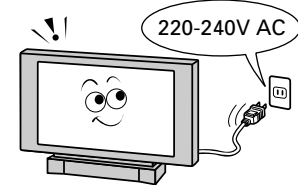

**About the fuse**

In a three pin earthing-type, the fuse fitted in this plug is approved by ASTA or BSI to BS1362. It should only be replaced by a correctly rated and approved type and the fuse cover must be refitted.

**Never insert or remove the power plug with wet hands.**

This may cause electric shock.

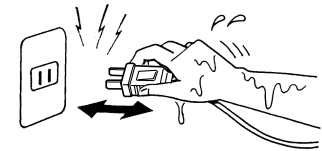

**Never place the TV in an unstabilized location such as on a shaky table, incline or location subject to vibration.**

The TV may drop or fall down which may cause injury or damage.

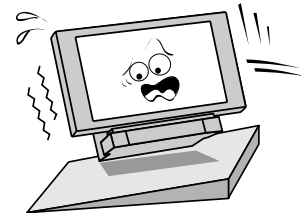

**Never block or cover the slots and openings in the cabinet.**

- Never place the TV so that it is facing upwards, or on its side.
- Never place the TV into a closet or bookshelf where the ventilation is poor.
- Never spread a newspaper, tablecloth or curtain on the TV.
- When installing the TV against a wall, always keep the TV at least 10 cm from the wall.
- Never place the TV on a soft unstable surface, such as a carpet, or a cushion.

The inside of this TV will overheat if the ventilation holes are covered, blocked, or sealed, which may result in a fire.

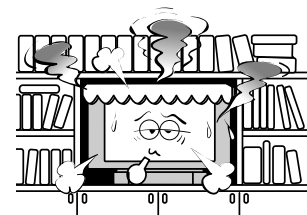

**Never place the TV near a heater or in direct sunlight.**

The surface of the cabinet or power cord may melt and result in fire or electric shock.

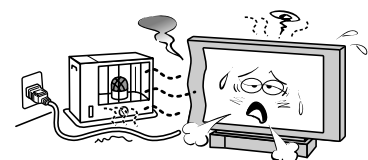

# Important Safety Instructions (continued)

## Installation (continued)

Never place the TV in an area exposed to high humidity levels, such as in a bathroom or close to a humidifier. This may cause a fire or an electric shock.

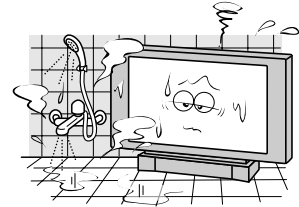

Never place the TV next to a stove where it will be exposed to oil, smoke, or steam, or in a location where there is a large quantity of dust. This may cause a fire or electric shock.

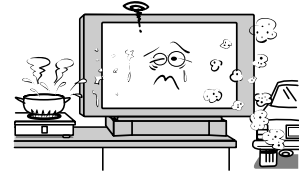

Install the TV in a horizontal, stable location. Install a steady tie to ensure that the TV is secure.

If the TV is not installed securely, it may lean or fall over and cause an injury.

### NOTICE OF POSSIBLE TV STAND INSTABILITY

Use this TV with the TOSHIBA TV stand recommended in the "Specifications" section only.

Use with other stands may result in instability, causing possible injury or death.

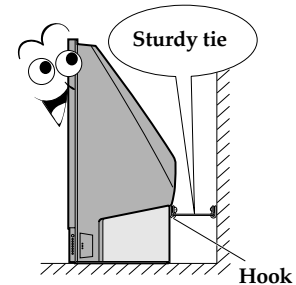

### Precautions for moving the TV

- When moving the TV, be sure to remove the power plug from the wall outlet and disconnect the antenna cable and audio/video cables, any steady ties. Fire or electric shock may result if the power cord is damaged.
- When carrying the TV, at least two people are needed. Be sure to carry it upright.
- Never carry the TV with the screen facing up or down.

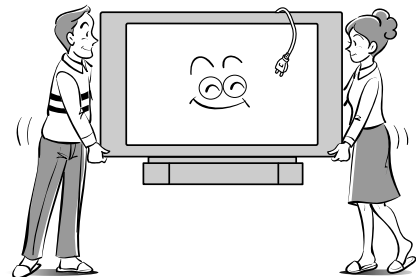

### Precautions for installing on outdoor antenna

An outside antenna system should not be located in the vicinity of overhead power lines, or other electric light or power circuits.

If the antenna falls down or drops, it may cause injury or electric shock accidents.



## Use

**Never place hot objects or open flame sources, such as lighted candles or nightlights on, or close to the TV.**  
High temperatures can melt plastic and lead to fires.

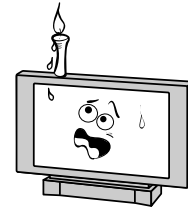

**Never place anything heavy on top of the TV.**  
This may cause the balance to become uneven, resulting in the TV falling over, dropping or causing an injury.



**The apparatus shall not be exposed to dripping or splashing and that no objects filled with liquids, such as vases, shall be placed on the apparatus.**

When liquids are spilled or small items are dropped inside the TV, this may cause a fire or an electric shock. If small objects drop inside the TV, turn off the TV and remove the power plug from the outlet immediately and contact a service technician.

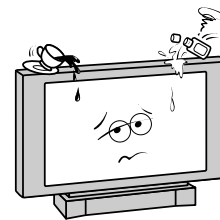

**Never insert objects (metal or paper) or pour water inside the TV from ventilation holes and other places.**

These items may cause a fire or an electric shock. If these objects are inserted inside the TV, turn off the TV and remove the power plug from the outlet immediately and contact a service technician. Be especially careful that children do not insert objects in the TV.

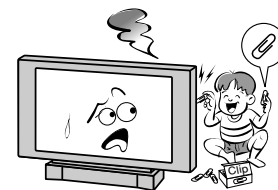

**Never stand or climb on the TV.**

Be especially careful in households with children to prevent them from climbing on top of the TV. It may move, fall over, break, become damaged or cause an injury.



**When the TV will not be used for a long period of time, such as during vacation or travel, remove the power plug from the wall outlet for safety.**

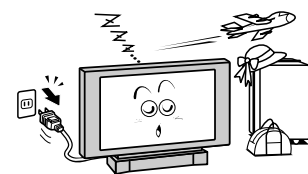

# Important Safety Instructions (continued)

## Use (continued)

**Never pull on the power cord when removing the plug from the wall outlet.**

Always hold the plug firmly when removing it. If the power cord is yanked, the cord may become damaged and fire or electric shock may occur.

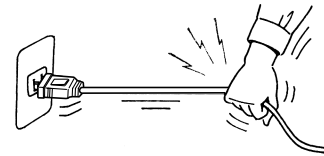

**Never cut, break, modify, twist, bunch up or bent the cord or apply excessive force or tension to it.**

Never place heavy objects on the cord or allow it to overheat as this may cause damage, fire or electric shock. Contact a service technician if the power cord is damaged.

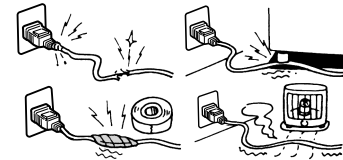

**If there is thunder or lightning, never touch the antenna cable or other connected cables.**

You may suffer an electric shock.

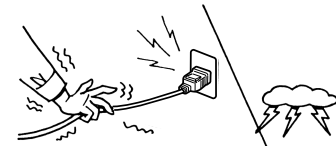

## Service

**Never repair, modify or disassemble the TV by yourself.**

If it may cause a fire or an electric shock. Consult a service technician for inspection and repairs.

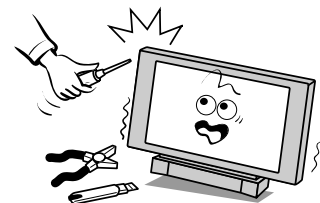

**When a malfunction occurs, or if smoke or an unusual odor comes from the TV, turn off the TV and remove the power plug from the outlet immediately.**

Make sure that the smoke or smell has stopped, then contact a service technician. If the TV is still used in this condition, it may then cause a fire or an electric shock.

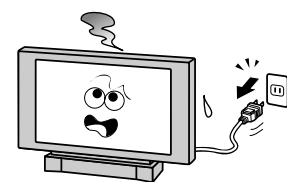

## Service (continued)

**If the TV is dropped or the cabinet is broken, turn off the TV and remove the power plug from the outlet immediately.**

If the TV is still power used in this condition, it may cause a fire or an electric shock or an injury. Contact a service technician for inspection.

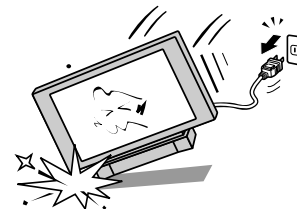

**When the TV reaches the end of its useful life, ask a qualified service technician to properly dispose of the TV.**

Note:

The lamp unit contains a small amount of mercury. Disposal of mercury may be regulated due to environmental considerations.

Dispose of the used lamp unit by the approved method for your area. For disposal or recycling information, please contact your local authorities.

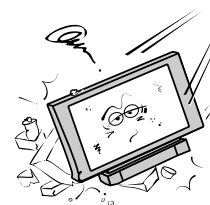

## Exemptions

- Toshiba is not liable for any damage caused by fires, natural disaster (such as thunder, earthquake, etc.), acts by third parties, accidents, owner's misuse, or uses in other improper conditions.
- Toshiba is not liable for incidental damages (such as profit loss or interruption in business, modification or erasure of record data, etc.) caused by use or inability to use of product.
- Toshiba is not liable for any damage caused by neglect of the instructions described in the owner's manual.
- Toshiba is not liable for any damage caused by misuse or malfunction through simultaneous use of this product and the connected equipment.

## Cleaning

**Remove the power plug before cleaning.**

Never use solvents such as benzine or thinner to clean the TV.

- These solvents may distort the cabinet or damage its finish.
- If rubber or vinyl products remain in contact with the TV for a long time, a stain may result.

If the cabinet becomes dirty, clean it with a soft, dry cloth.

When cleaning the screen:

- Wipe the screen gently with a soft, dry cloth.

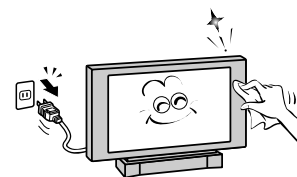

**Periodically disconnect the power plug from the outlet and check it. If dust has collected on the power plug connectors, clean off the dust. This dust may cause a fire due to reduced insulation on the plug.**

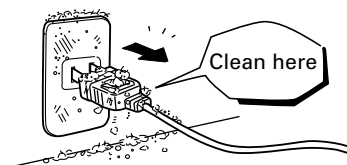

# Important information

## Important information

### Important notes about your DLP™ projection TV

**WARNING: TO REDUCE THE RISK OF ELECTRIC SHOCK, DO NOT REMOVE TV COVERS. NO USER-SERVICEABLE PARTS INSIDE. REFER SERVICING TO QUALIFIED SERVICE PERSONNEL.**

1)The light source for this TV is a projection lamp unit with a limited service life. When the lamp wears out, the picture may become dark or black, or the lamp may fail, at which time you must replace the lamp unit.

The length of service life varies depending on product use and user settings. See “Selecting the lamp mode” on page 25 for information on switching the lamp mode.

#### To replace the lamp unit

**Please contact the nearest Toshiba Authorized Service Center or dealer:**

- if the picture darkens and/or colors fade;
- if the screen (lamp) does not light (LED indication #3, page 45); or
- if you hear a loud noise and the picture goes black, which may indicate a lamp rupture (LED indication #3, page 45).

**Only the replacement lamp unit model listed below can be used with this TV.**

**Using any other lamp may cause damage to the TV and/or lamp.**

**Model No.: D95-LMA ( Stock No. 23311168)**

2)Each time you turn on the TV, it may take several minutes to go from no picture to full picture brightness.

3)The display of this TV is manufactured using an extremely high level of precision technology; however, an occasional pixel (dot of light) may show constantly on the screen.

This is a structural property of DLP™ (Digital Light Processing™) technology in the TV, and is not a sign of malfunction. Such pixels are not visible when the picture is viewed from a normal viewing distance.

4)Depending on the media you are viewing, it is possible, although unlikely, that a limited number of viewers may see a “rainbow effect” on the screen, which can, in rare instances, result in eye fatigue. This is a rare occurrence related to technology of this type, and is not a sign of TV malfunction.

5)Always sit approximately 3-8 m away from the TV and as directly in front of it as possible. The picture quality may be affected by your viewing position and length of viewing time. If you sit too closely to the TV for too long, you may suffer from eye fatigue.

6)This TV contains several cooling fans to moderate the internal temperature. You may be able to hear the fans for several minutes after the TV is turned off. This is a function of the Quick restart feature and is not a sign of TV malfunction. You can set the Quick restart feature to stop the fans as soon as the TV is turned off. See “Setting the Quick restart feature” on page 33.

7)The orange and blue LED lights at the bottom center of the TV front indicate your TV’s current status. If either light flashes, see “LED indications” on page 45 for details.

8)Review all safety and operating information in this owner’s manual before you use your TV.

The DLP logo and DLP medallion are trademarks of Texas Instruments.

#### About insecticide spray

- Never spray volatile compounds such as insecticide on the cabinet. This may cause a discoloration or damage the cabinet.

#### Moisture Condensation

- If the room temperature suddenly rises (or if the TV is moved from a cool place to a hot place), condensation may occur on the lenses resulting in picture distortion or color fading. In such a case, simply wait a while (with the power on) and the condensation will evaporate.



# Installation

## Connecting an antenna

Optimum reception of color requires a good signal and will generally mean that an outdoor antenna must be used. The exact type and positioning of the antenna will depend upon your particular area. Your Toshiba dealer or service personnel can best advise you on which antenna to use in your area. Do not plug the power cord until you have finished connecting the antenna.

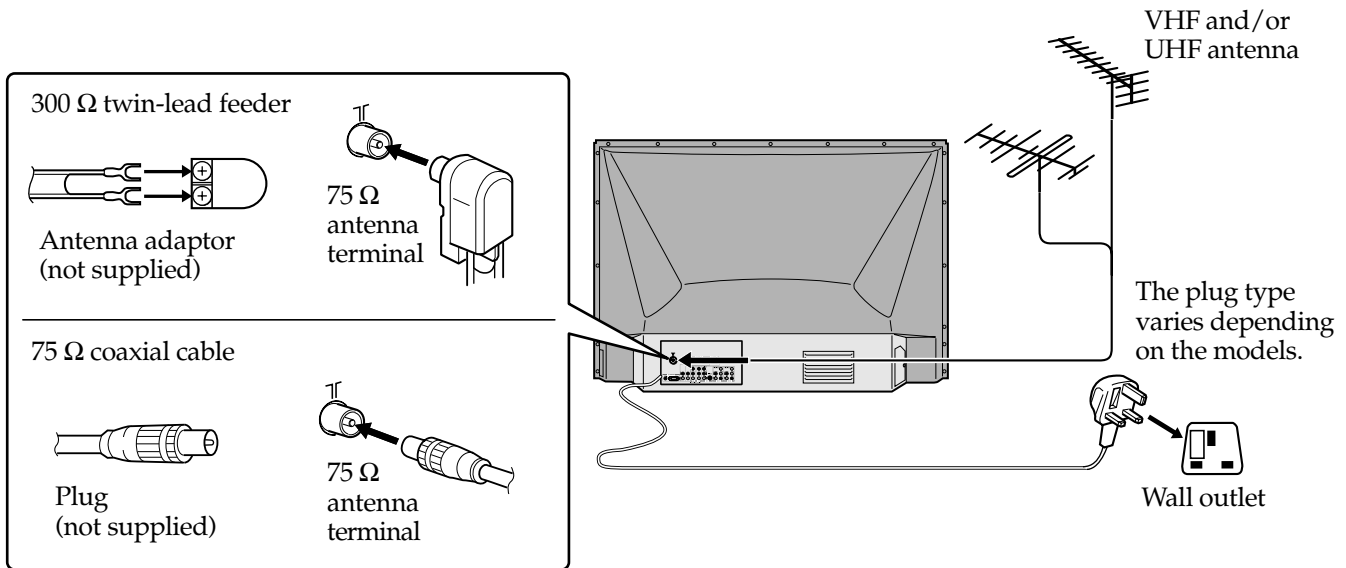

## Installing the remote control batteries

Remove the battery cover. Insert two R03 (AAA) batteries matching the -/+ polarities of the battery to the -/+ marks inside the battery compartment.

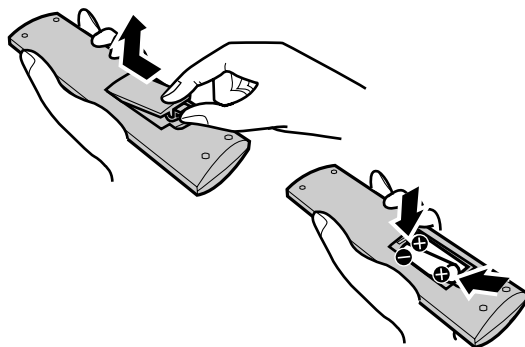

### Caution:

- Dispose of batteries in a designated disposal area. Do not throw batteries into a fire.
- Attention should be drawn to the environmental aspects of battery disposal.
- Do not mix battery types or combine used batteries with new ones.

## Effective range

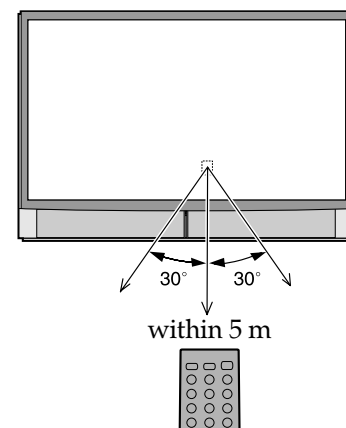

### Notes:

- If the remote control does not operate correctly, or if the operating range becomes reduced, replace both batteries with new ones.
- If the batteries are dead or if you will not use the remote control for a long time, remove the batteries to prevent battery acid from leaking into the battery compartment.

# Exploring your new TV

- You can operate your TV using the buttons on the right side panel or the remote control. The back and side of the panel provide the terminal connections to connect other equipment to your TV. See "Equipment connections" on pages 38-40.
- Model 62CM9UE is used in this manual for illustration purpose.

## TV right side

For the use of each control, see the pages in brackets.

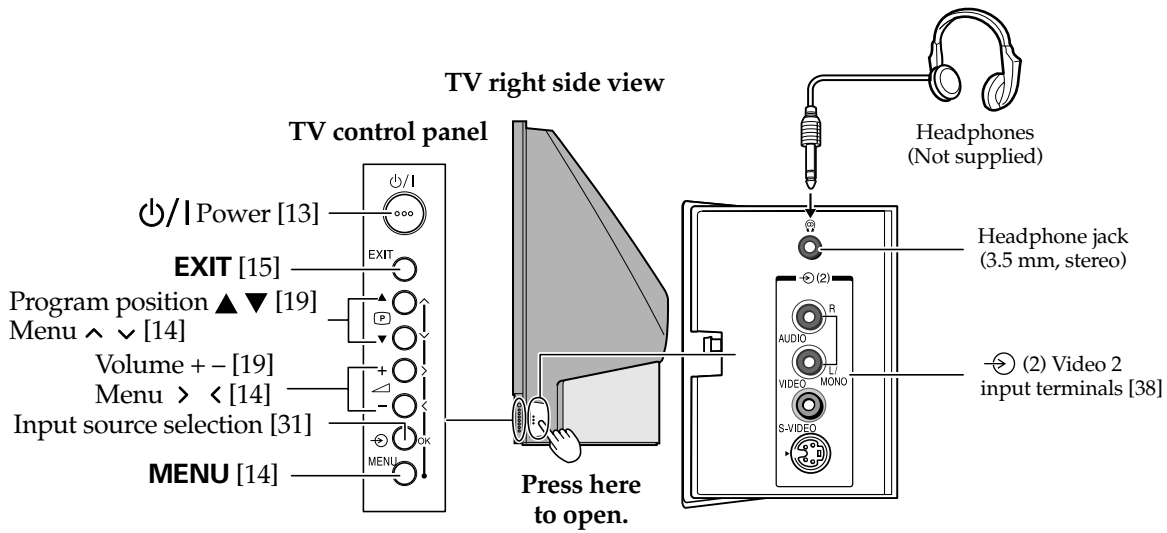

**Note:**  
Inserting the Headphone jack will mute the sound from all speakers and deliver normal stereo left and right sounds to the headphones.

## TV front

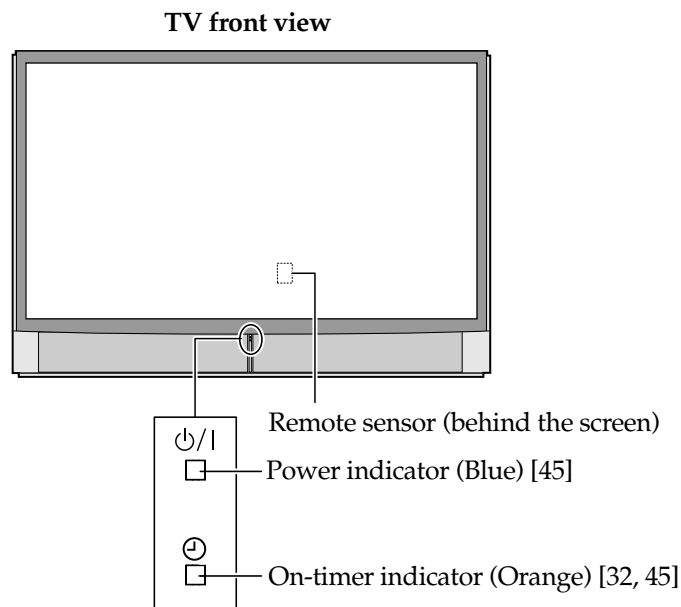

## TV back

TV back view

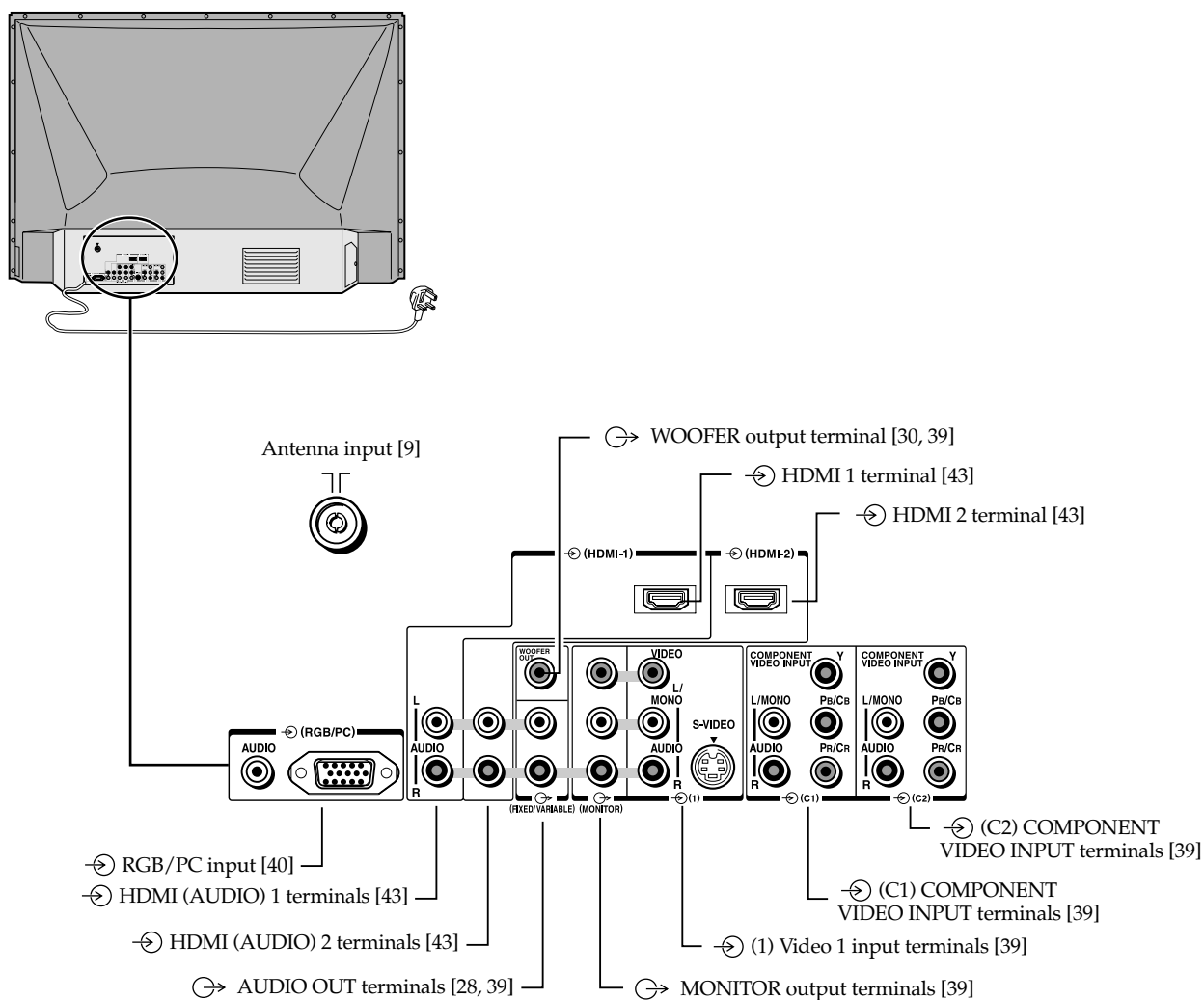

# Learning about the remote control

## Location of controls

For the use of each control, see the pages in brackets.

Getting Started

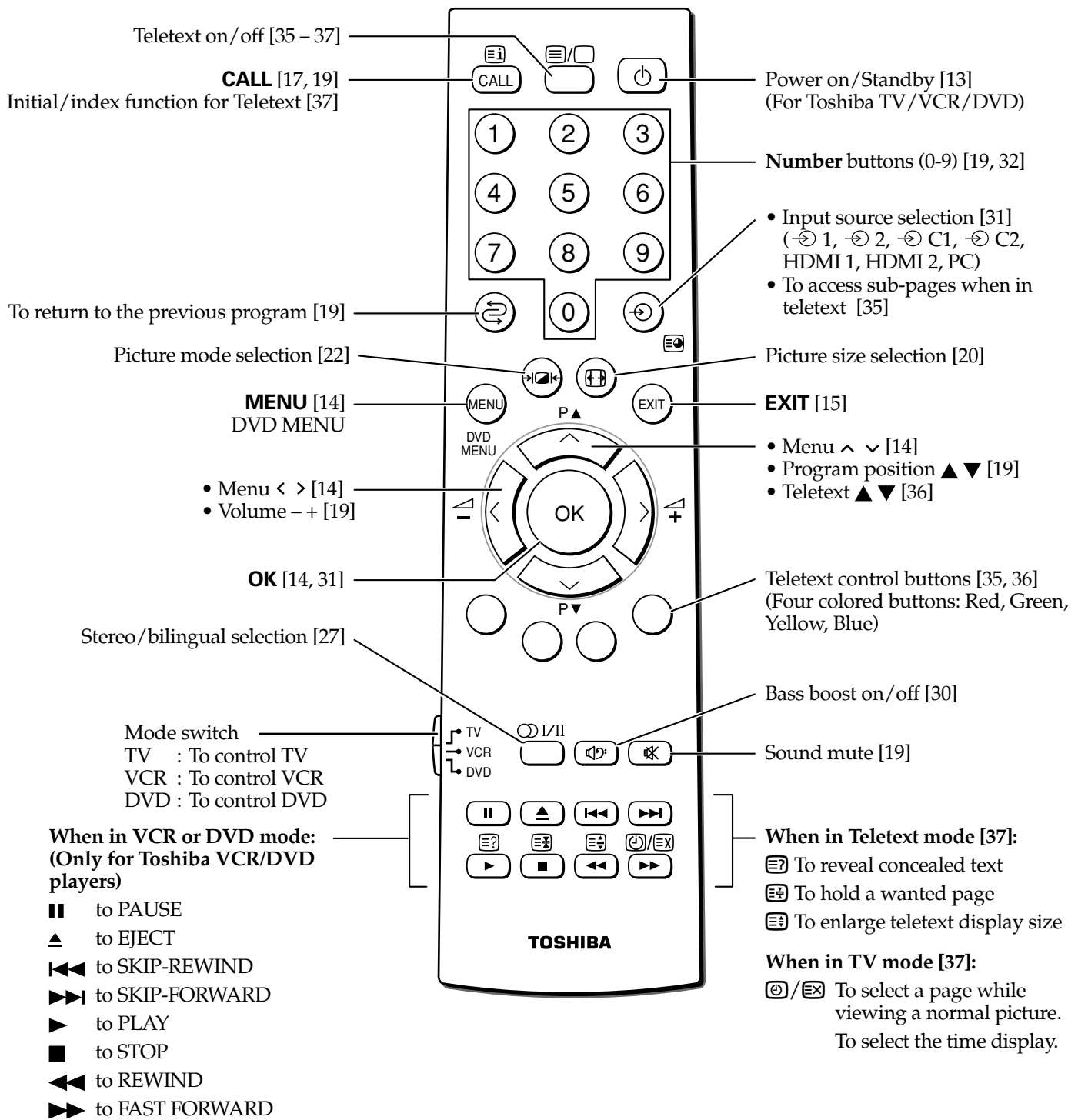

# Turning the TV on

- Plug the power cord into a wall outlet.

## Switching on the TV

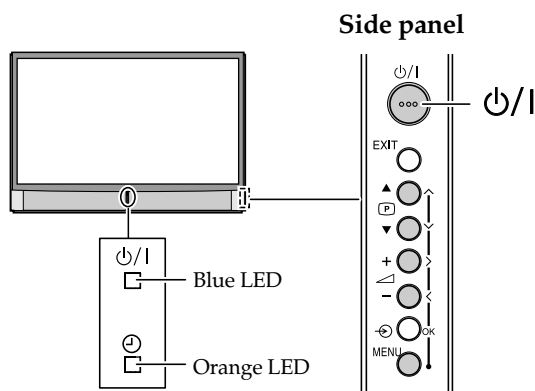

### Note:

If you watch black and white programs when the color system mode is set to Auto, color noise may appear on the screen. In this case, select the appropriate Color system (For the system of each country or region, refer to pages 17 and 48).

After you plug in the TV power cord, make sure the blue LED on the TV front is lit.

- 1 Press the Power button on the TV control panel or press the button on the remote control. The orange LED will blink for several seconds until the picture appears.

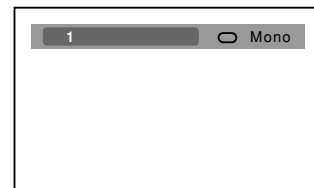

### Note:

The Quick restart setting will affect the amount of time it takes for the picture to appear when you turn on the TV. See page 33 for details.

## Switching off the TV

- 1 Press the Power button on the TV control panel or press the button on the remote control to switch to the standby mode.

### Notes:

- When the TV will not be used for a long period of time, such as during vacation or travel, remove the power plug from the wall outlet.
- The TV will automatically turn off after approximately 15 minutes if it is tuned to a vacant channel or a station that completes its broadcast for the day. This function does not work in external input mode or blue screen off mode.
- If power is cut off while you are viewing the TV, the Last Mode Memory function turns on the TV automatically when power is applied again. If power is going to be off for a long time and you are going to be away from your TV, unplug the power cord to prevent the TV from turning on in your absence.

# Learning about the menu system

- We suggest you familiarize yourself with the display chart before using the menu system:
  - Press the **MENU** button to display menu, then press the < or > button to select main menu headings.
  - Press the v or ^ button to select an item.
  - Press the < or > button to select or adjust setting.
  - Press the **OK** button to display the next menu.

## Menu display chart

### PICTURE menu

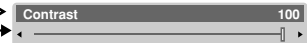
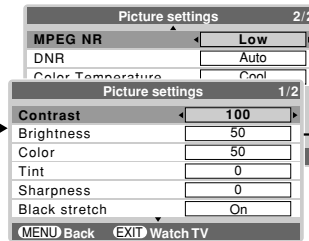
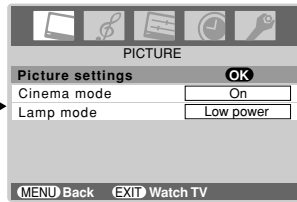
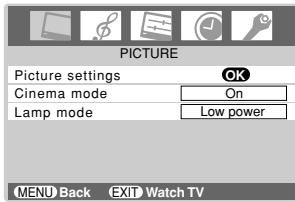

### SOUND menu

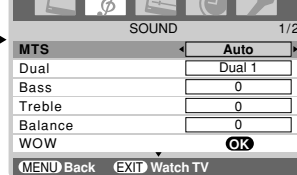
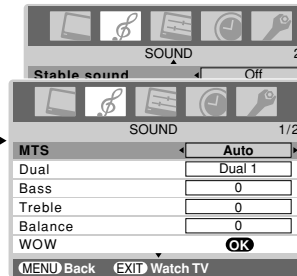
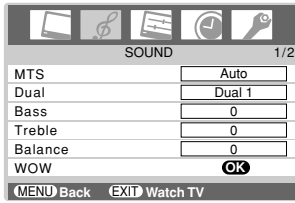

### SET UP menu

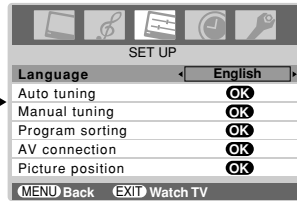
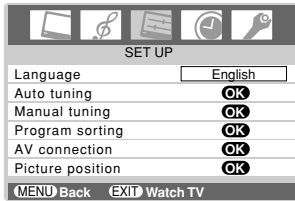

### TIMER menu

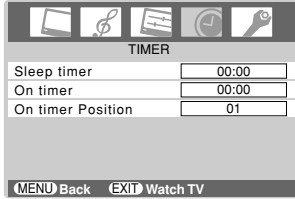

### FUNCTION menu

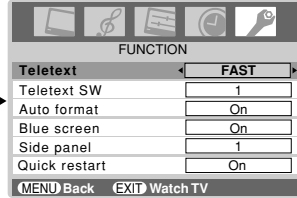
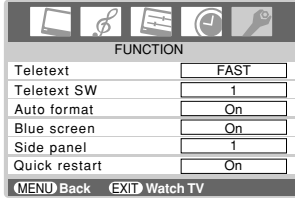

## Selecting a language

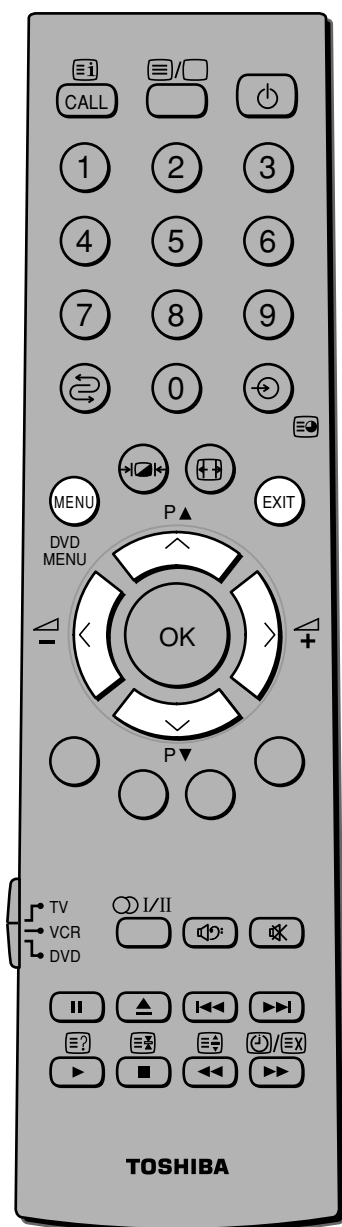

Choose from seven different languages (English, Chinese (CS), Malay, Thai, Vietnamese, Russian, Arabic, Persian and French) for the on-screen display.

- 1 Press the **MENU** button, then press the < or > button to display the SET UP menu.

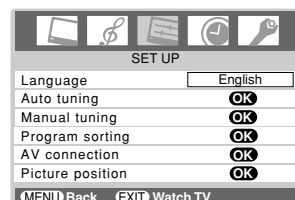

- 2 Press the ∨ or ∧ button to select Language.

- 3 Press the < or > button to select the desired language.

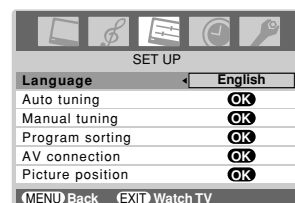

### Notes:

- In the video input mode (1, 2, C1, C2, HDMI 1, HDMI 2), Auto tuning, Manual tuning and Program sorting are not available. Instead, Manual setting appears in the SET UP menu (see page 31).
- If you connect external equipment via component video source to external input, Color system selection in the Manual setting menu is not available.
- If you do not make a selection for a while, the menu display disappears automatically.
- If you want to close the menu display instantly, press the **EXIT** button.
- To return to the previous menu, press the **MENU** button.
- The ∧/∨ buttons function as the Program position P ▲ / P ▼ buttons when there is no menu display on the screen.
- The </> buttons function as the Volume ▲+ / ▲- buttons when there is no menu display on the screen.
- In the PC input mode, PC Setting appears in the SET UP menu (see page 41).

# Programming channel memory

- First, use the Auto tuning function to preset all the active channels in your area automatically. Then, arrange the preset channels with the Manual tuning function so that you can tune into only desired channels.
- Use the Channel search operation if desired channels cannot be preset with the Auto tuning or if you would like to preset channels to specific position numbers one by one.

## System selection, Auto tuning

Getting Started

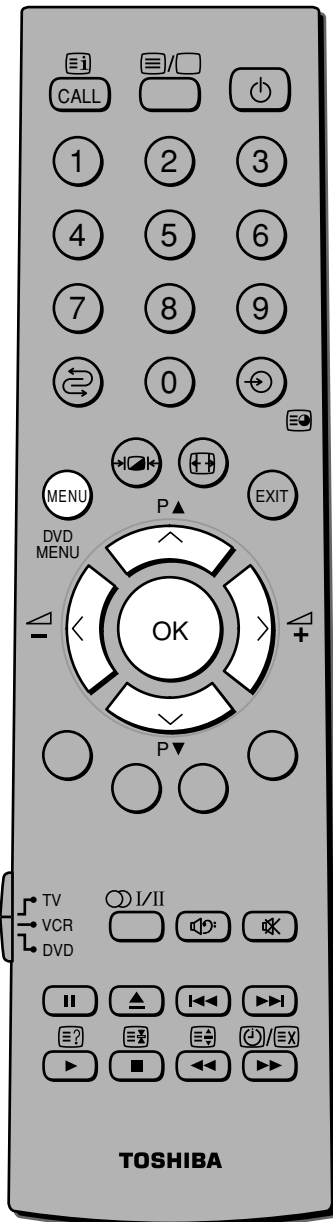

**1** Press the **MENU** button, then press the < or > button to display the SET UP menu.

**2** Press the ∨ or ∧ button to select Auto tuning.

**3** Press the **OK** button to display the Auto tuning menu.

**4** Press the **OK** button to start the automatic search. The programming will begin from the current position for all available stations. The slide bar will move along the line as the search progresses.

If you make a mistake, simply repeat steps 1-4 to start again from the beginning.

**5** When the automatic search is complete, the TV will automatically return to the first program position.

**6** Press the **P▲** or **P▼** button to select the programmed position.

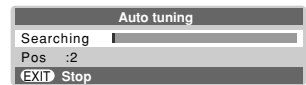
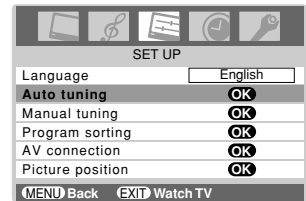

## Manual tuning

**1** Press the **MENU** button, then press the < or > button to display the SET UP menu. Press the ∨ or ∧ button to select Manual tuning.

**2** Press the **OK** button to display the Manual tuning menu. Press the ∨ or ∧ button to select the program position you want to arrange.

**3** Press the **OK** button to display the breakdown menu. Press the < or > button to select an item, then press the ∨ or ∧ button to select the item as shown on the next page.

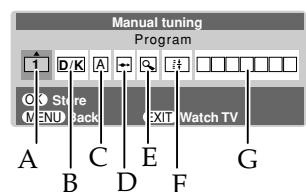
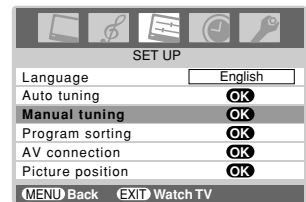



## Manual tuning (continued)

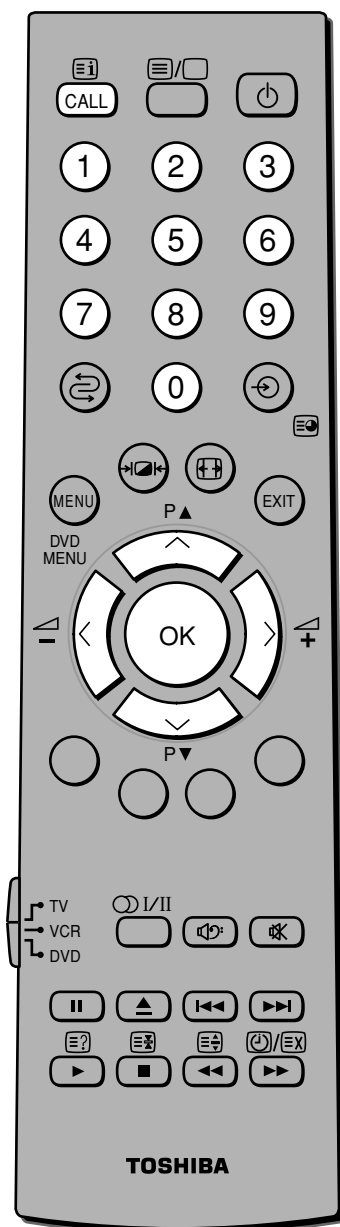

- A. Program position selection  
 B. Sound system (see page 48)  
 C. Color system (see page 48)  
 A : Automatic (factory set), P : PAL, S : SECAM  
 N4 : NTSC 4.43 (MHz), N3 : NTSC 3.58 (MHz)  
 If the color of a certain channel is abnormal, the automatic color system selection (A) may have malfunctioned, or sound system selection is wrong. In such a case, select another color and/or sound system (see page 48).
- D. Program position skip selection  
 Press the  $\wedge$  or  $\vee$  button to turn the program position skip option on " $\leftarrow$ " or off " $\rightarrow$ ".  
 The program position will then be skipped when you select channels with the **P $\blacktriangle$**  or **P $\blacktriangledown$**  button.  
 The " $\leftarrow$ " mark will appear beside a program position number when you use the **Number** button on the remote control.
- E. Channel search operation  
 Press the  $\wedge$  button to search up the band or the  $\vee$  button to search down the band.  
 Press the  $\vee$  or  $\wedge$  button repeatedly until your desired channel is displayed.  
 When a station/satellite is found, it will be displayed.  
**DO NOT PRESS ANY OTHER BUTTONS WHILE THE SET IS TUNING.**
- F. Auto Fine Tuning  
 Press the  $\vee$  or  $\wedge$  button to turn the Auto Fine Tuning option on "F" or off "0".  
 The Auto Fine Tuning function automatically corrects slight fluctuations when receiving signals.  
 Manual Fine Tuning  
 While the Auto Fine Tuning turn off "0", press the  $\vee$  or  $\wedge$  button so that the better picture and sound are obtained.
- G. Label  
 Station labels appear under the program position display each time you turn on the TV, select a channel, or press the **CALL** button.

To change or create station labels:

- 1) Press the  $\vee$  or  $\wedge$  button repeatedly to select a character for the first space, then press the  $\blacktriangleright$  button.

$\leftarrow$ A $\leftrightarrow$ Z $\leftrightarrow$ ( $\leftrightarrow$ ) $\leftrightarrow$ \* $\leftrightarrow$ + $\leftrightarrow$ , $\leftrightarrow$ - $\leftrightarrow$ . $\leftrightarrow$ / $\leftrightarrow$ 0 $\leftrightarrow$ 9 $\leftrightarrow$ " $\leftrightarrow$

\*(blank space)

- 2) Repeat step 1) to enter the rest of the characters. If you would like a blank space in the label name, you must choose a blank space from the list of characters.

Press the **OK** button to store your settings.

# Programming channel memory (continued)

- This TV is capable of receiving a number of different channels depending upon where you live.
- Program sorting is an easy way of storing each channel on the program position of your choice.

## Program sorting

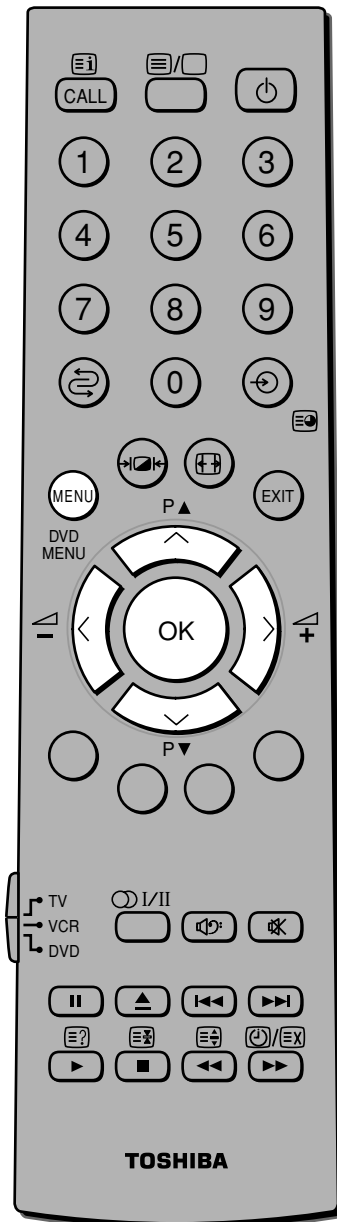

**Ex.:** To swap channel ABCD (Prog.1) for channel MNOP (Prog.4):

- 1 Press the **MENU** button, then press the < or > button to display the SET UP menu. Press the ^ or v button to select Program sorting.
- 2 Press the **OK** button to display the Program sorting menu.
- 3 Press the ^ or v button to select the channel ABCD, then press the > button.
- 4 Press the v button to select the new position "4", then press the < button.
- 5 Press the ^ button to select the channel MNOP, then press the > button.
- 6 Press the ^ button to select the new position "1", then press the < button.
- 7 Confirm new sorting list.

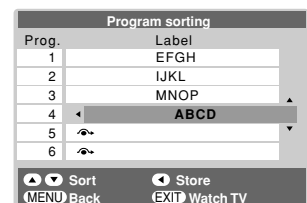
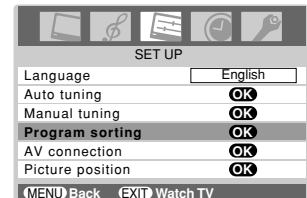

# Watching TV programs

## Volume, Sound mute, Changing program positions, Program return, On-screen information

TV control panel

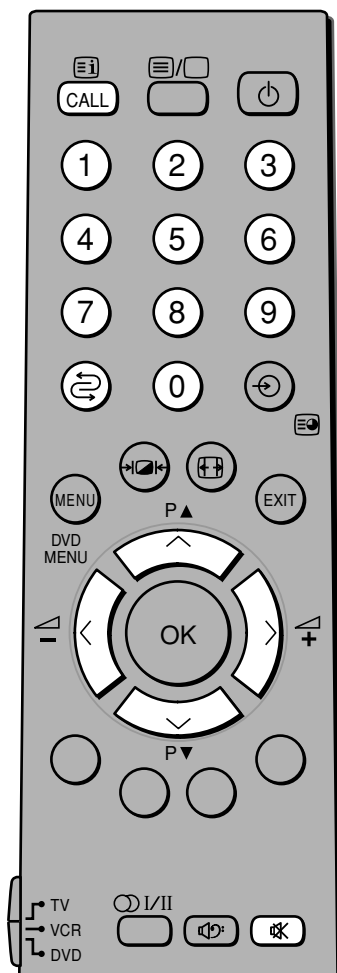
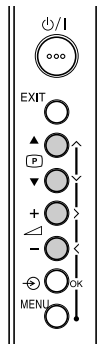
**Note:**

The program position selection change between different format channels takes several seconds.

**To alter the volume:**

- 1 Press the  $\triangle +$  or  $\triangle -$  button to raise or lower the volume.

**To mute the sound:**

- 1 Press the  $\times$  button. The word Sound mute appears on the screen.
- 2 Press the  $\times$  button again to restore the sound.

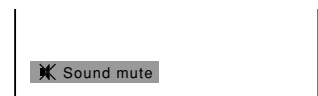
**To change program position:**

- 1 Enter the desired program position number using the **Number** buttons on the remote control.

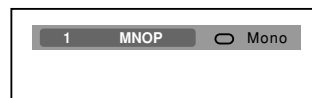

For program positions below 10, use 0 and the required number.

- 2 You can also change the program position by using the **P▲** or **P▼** button.

The program position will be displayed on the screen with the Mono/Stereo/Dual audio status.

**To switch between two program positions:**

You can switch two program positions without entering actual position number each time.

- 1 Select the first program position you want to view.
- 2 Select the second program position with the **Number** buttons (0-9).
- 3 Press the  $\rightleftarrows$  button. The previous channel will be displayed.

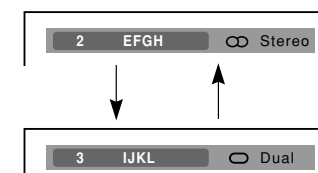

Each time you press the  $\rightleftarrows$  button, the TV will switch back and forth between the two program positions.

**To display the on-screen information:**

- 1 Press the **CALL** button to display the following on-screen information. The information will disappear in 6 seconds.

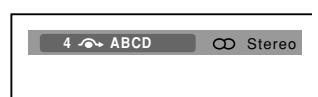

- Program position or external input mode selected
- Program skip on/off information
- Station label (if set)
- Mono/Stereo/Dual audio status

- 2 To erase the display instantly, press the **CALL** button again.

# Viewing the wide-screen picture format

- This TV is capable of showing broadcasts in a number of formats. Depending on the type of broadcast being transmitted, you may select between Super live, Cinema, Subtitle, 14:9, Wide and 4:3.

## Picture size selection

Using the TV's features



### Notes:

- Using the special functions to change the size of the displayed image (e.g. changing the height/width ratio) for the purpose of public display or commercial gain may infringe on copyright laws.
- The picture size selection is not available for 720p and 1080i input signals (fixed to Wide).
- If the aspect ratio of the selected format is different from the one of the TV transmission or video program, it can cause a difference in vision. Change to the correct aspect ratio picture size.
- When the PC input mode (see page 31) is selected, the picture size selection is wide or 4:3 only.

Press the  button repeatedly to view the options available.

### Super live

This setting will enlarge the 4:3 image to fit the screen by stretching the image vertically and horizontally, holding the correct proportions at the center of the image.

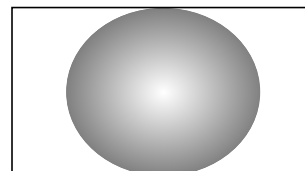

### Cinema

When watching "letterbox format" films/video tapes, this setting will eliminate or reduce the black bars at the top and bottom of the screen by zooming in and selecting the image without distortion.

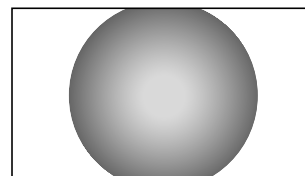

### Subtitle

When subtitles are included on a letterbox format broadcast, this setting will raise the picture so that the most of text is displayed.

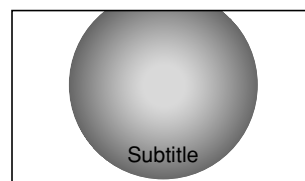

### 14:9

Use this setting when watching a 14:9 broadcast.

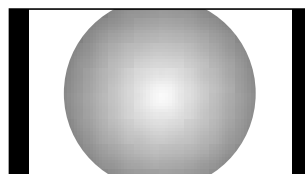

### Wide

Use this setting when watching a wide-screen DVD, wide-screen video tape or a 16:9 broadcast (when available). Due to the range of wide-screen formats (16:9, 14:9, 20:9 etc.), you may see bars on the top and bottom of the screen.

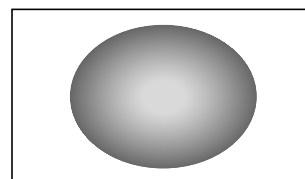

### 4:3

Use this setting to view a true 4:3 broadcast.

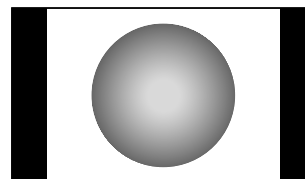

# Picture position, Reset

## Picture position adjustment

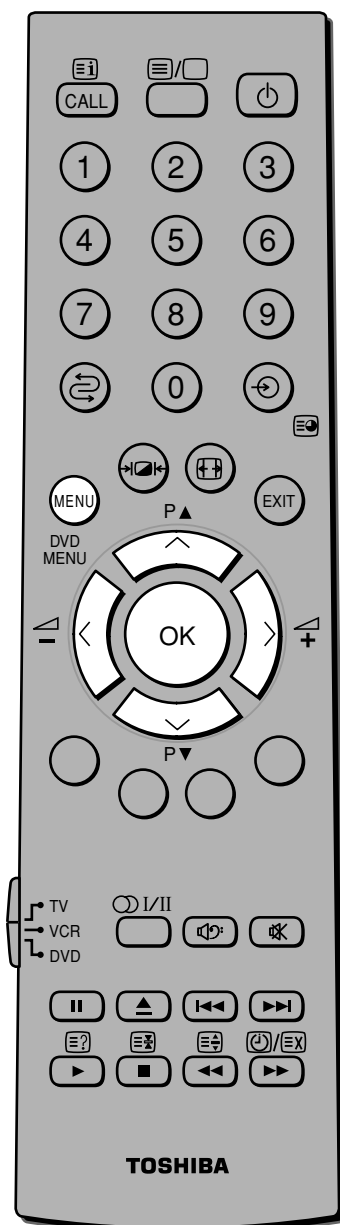

**Notes:**

- When the picture format is in Wide or 4:3 mode, only the Horizontal position can be adjusted.
- The picture position adjustment is not available for 720p and 1080i input signals.

Adjustment to the position of the picture may be made to suit your viewing preferences.

**To adjust the picture position:**

- 1 Press the **MENU** button, then press the < or > button to display the SET UP menu.
- 2 Press the ∨ or ∧ button to select Picture position.
- 3 Press the **OK** button to display the Picture position menu.  
  
The menu will vary depending upon the widescreen format you have previously chosen.
- 4 Press the ∨ or ∧ button to select an item you want to adjust.
- 5 Press the < or > button to adjust the settings as required.

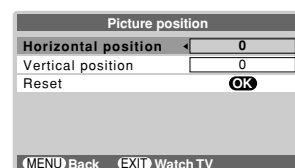
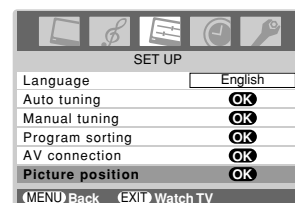

## Reset (Picture position adjustment)

This function resets your picture position settings to the factory settings.

**To reset the picture position:**

- 1 Press the **MENU** button, then press the < or > button to display the SET UP menu.
- 2 Press the ∨ or ∧ button to select Picture position, then press the **OK** button.
- 3 Press the ∨ or ∧ button to select Reset, then press the **OK** button.

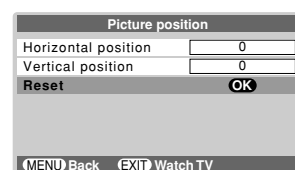
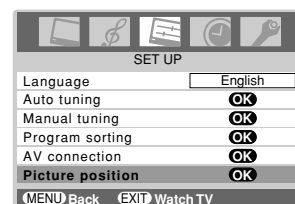

# Picture quality adjustment

## Picture quality adjustment

Using the TV's features

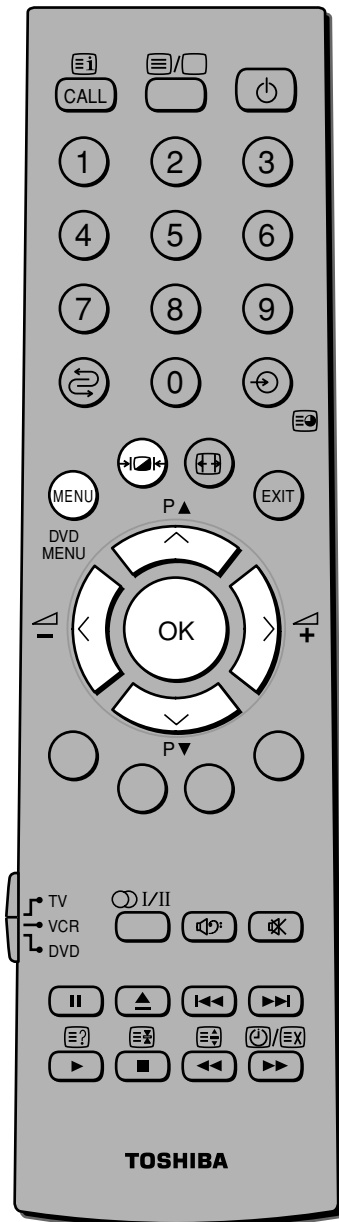

**Notes:**

- The Tint may only be adjusted on a tape which has been recorded and played back on an NTSC VCR.
- In the PC input mode (see page 31), Color, Tint and Sharpness modes are not selectable.

**To select the picture mode:**

You can select the picture quality instantly among three preset modes and one user-set mode.

- Press the button to select the desired picture quality.

Dynamic, Standard, Mild and Memory (user-set) can be selected cyclically.

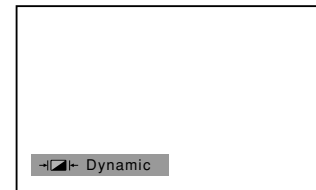

Mode	Picture quality
Dynamic	bright and dynamic picture
Standard	standard picture
Mild	soft picture
Memory	the picture quality you set

**Note:**

In the PC input mode (see page 31), this mode is not available.

**To adjust the basic picture quality:**

- 1 Press the **MENU** button, then press the < or > button to display the PICTURE menu.
- 2 Press the v or ^ button to select the Picture settings menu, then press the **OK** button.
- 3 Press the v or ^ button to selects Contrast, Brightness, Color, Tint or Sharpness, then press the < or > button to adjust the level.

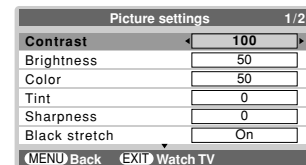

Selection	< Pressing >	
Contrast	lower	higher
Brightness	darker	lighter
Color	paler	deeper
Tint	reddish	greenish
Sharpness	softer	sharper

## To activate the black stretch

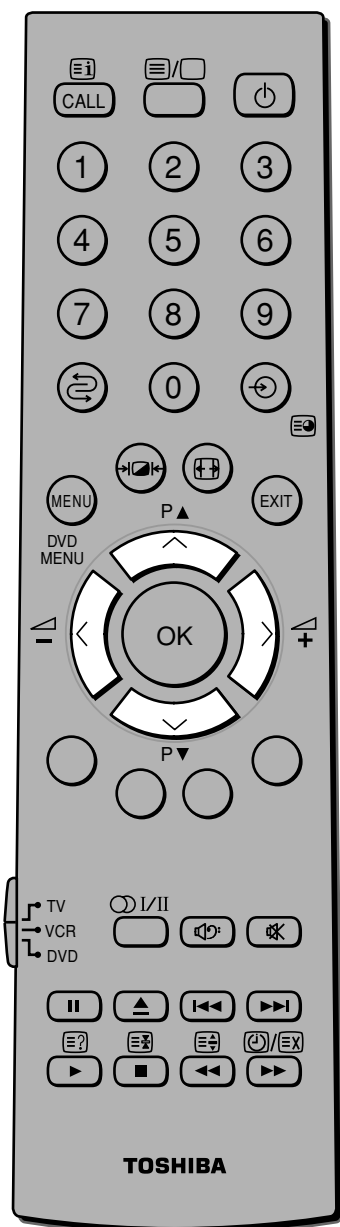

This function increases the strength of dark areas of the picture which improves definition.

- 1 From the Picture settings menu, press the  $\nabla$  or  $\blacktriangle$  button to select Black stretch on the 2nd page.

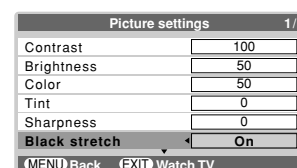

- 2 Press the  $\leftarrow$  or  $\rightarrow$  button to select On or Off.



**Note:**

This function is not available in the PC input mode (see page 31).

## To activate the MPEG NR (Noise Reduction)

If MPEG pictures include mosquito noise (grainy outlines around images within the picture which may result depending on compression and conversion rates), it may be reduced by using this function.

- 1 From the Picture settings menu, press the  $\nabla$  or  $\blacktriangle$  button to select MPEG NR on the 2nd page.

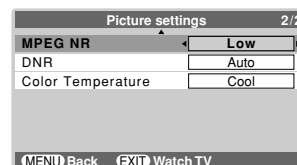

- 2 Press the  $\leftarrow$  or  $\rightarrow$  button to select Off, Low, Middle or High.



**Note:**

This function is not available in the PC input mode (see page 31).

## To activate the DNR (Digital Noise Reduction)

If the received signal is weak and the picture is blurry, the picture may be improved by using this function.

- 1 From the Picture settings menu, press the  $\nabla$  or  $\blacktriangle$  button to select DNR on the 2nd page.

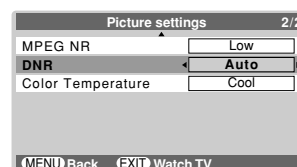

- 2 Press the  $\leftarrow$  or  $\rightarrow$  button to select Auto, Low, Middle, High or Off.



**Note:**

For 480i and 576i signals, the available selections are Auto, Low, Middle, High or Off. For 1080i signals, the available selections are Low, Middle, High or Off.

# Picture quality adjustment (continued)

## To select the color temperature

You can change the tone of the picture by selecting from three preset color temperatures: Cool, Normal or Warm.

- 1 Press the **MENU** button, then press the < or > button to display the PICTURE menu.
- 2 Press the ∨ or ∧ button to select the Picture settings menu, then press the **OK** button.
- 3 Press the ∨ or ∧ button to select Color Temperature on the 2nd page, then press the < or > button to select mode you prefer.

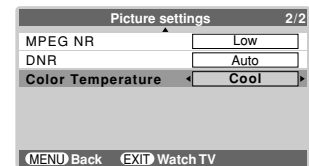

- Cool : Lends a blue hue to the picture.
- Normal : Neutral
- Warm : Lends a red hue to the picture.

## To use the cinema mode

A movie film's picture runs at 24 frames a second, whereas movie software such as DVD, etc., that you enjoy watching on television at home runs at 30 (NTSC) or 25 (PAL) frames a second. To convert this signal to reproduce a smooth motion and picture quality, select the On mode.

### Effective signal and setup conditions

- When the Video input mode is selected.
- When the input signal format is 480i and 576i.

- 1 Press the **MENU** button, then press the < or > button to display the PICTURE menu.
- 2 Press the ∨ or ∧ button to select Cinema mode, then press the < or > button to select On or Off.

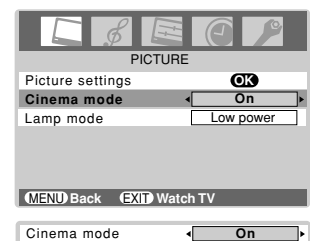

**Note:**  
A DVD movie with a subtitle is input from a DVD player, the Cinema mode may not work correctly.

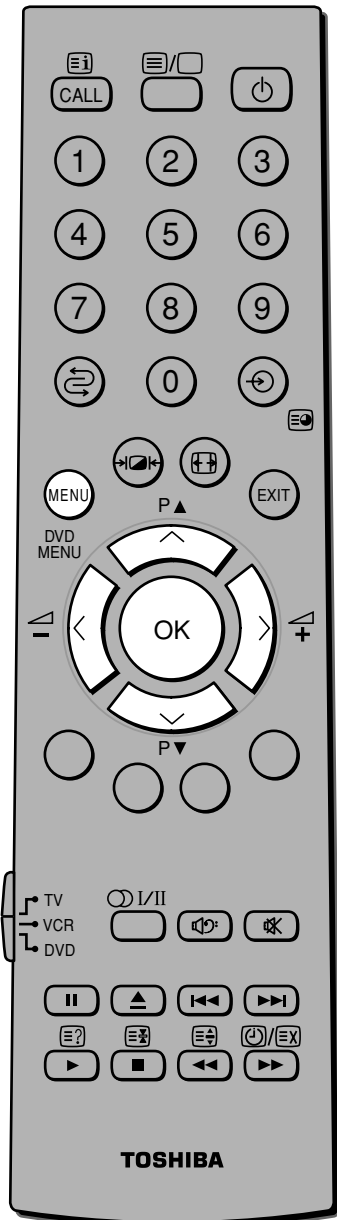

Using the TV's features



## Selecting the lamp mode

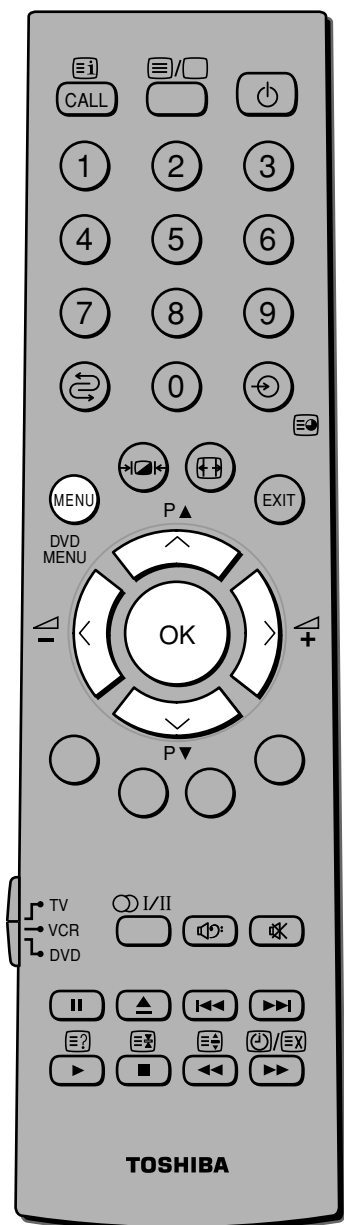

You can select either the High bright or Low power lamp mode.

- The High bright mode is useful when additional picture brightness is desired (such as in a bright room).
- The Low power mode reduces wear on the projection lamp. Using this mode should result in longer lamp life.

### To select the lamp mode:

- 1 Press the **MENU** button, then press the **<** or **>** button to display the PICTURE menu.
- 2 Press the **^** or **v** button to select Lamp mode, then press the **<** or **>** button to select High bright or Low power, whichever you prefer.

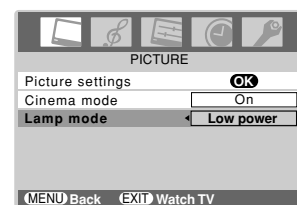

# Sound adjustment

## MTS (Multi-channel TV Sound) setting

Using the TV's features

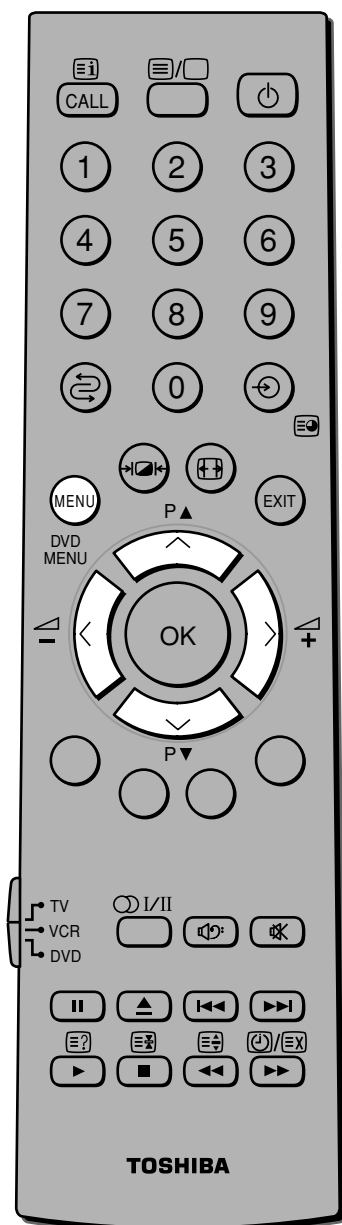

### Setting the MTS mode:

#### Auto mode

The MTS Auto mode automatically recognize stereo/bilingual programs depending on the broadcast signal.

- 1 Press the **MENU** button, then press the < or > button to display the SOUND menu.
- 2 Press the ∨ or ∧ button to select MTS, then press the < or > button to select Auto or Mono.

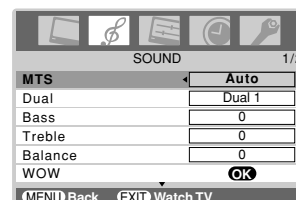

#### Mono mode

If you experience noise or poor reception of any stereo/bilingual program, set the MTS mode to Mono.

Noise will be reduced and reception may improve.

#### Note:

If you experience noise with a particular program on whose channel reception is usually good, try setting MTS mode to Auto, then switch the button to Mono (monaural) (see page 27).

## Selecting the Dual 1 or Dual 2 mode

You can hear only Dual 1 or Dual 2 sound selected, whenever bilingual programs are received.

- 1 Press the **MENU** button, then press the < or > button to display the SOUND menu.
- 2 Press the ∨ or ∧ button to select Dual, then press the < or > to select Dual 1 or Dual 2.

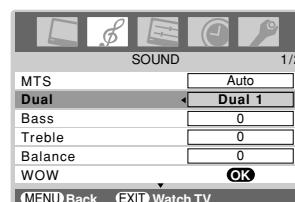

#### Notes:

- When the MTS setting is in Mono mode, the Dual menu is not selectable.
- The Dual menu setting status remains even if the TV is turned off.

## Stereo/Bilingual selection

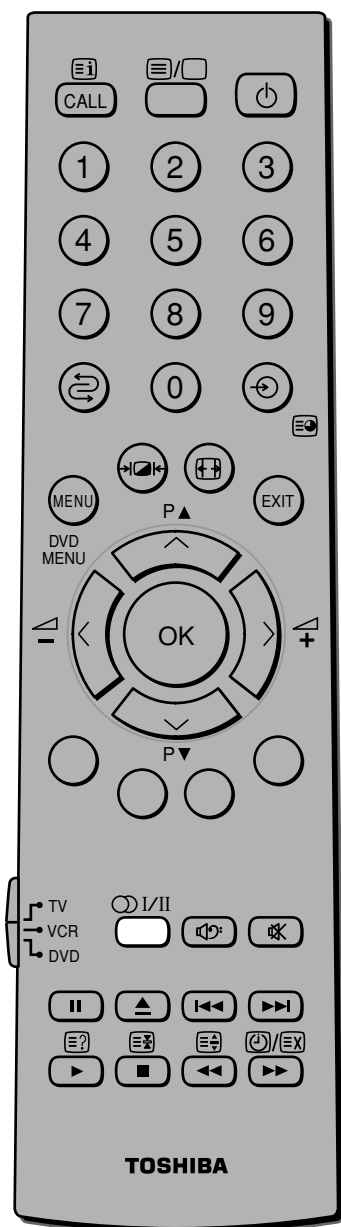

### To select the stereo programs:

- 1 When a stereo program is received, Stereo appears.
- 2 Press the button to select the stereo/monaural mode. Stereo and Mono appear cyclically on the screen.

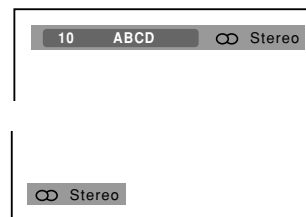

### To select the bilingual programs:

- 1 When a bilingual program is received, Dual appears.
- 2 Press the button to select the sound to be heard. The sound differs according to the transmission system: NICAM or German stereo/bilingual broadcast. Dual 1, Dual 2 and Mono appear cyclically on the screen.

Display	Sound to be heard	
	NICAM	German stereo/bilingual broadcast
Dual 1	Sub I sound	Main sound
Dual 2	Sub II sound	Sub sound
Mono	Main sound	—

#### Note:

These settings are not stored in the TV memory.

## Sound quality adjustment

### To adjust the sound quality:

- 1 Press the **MENU** button, then press the **<** or **>** button to display the SOUND menu.
- 2 Press the **∨** or **∧** button to select Bass, Treble or Balance.
- 3 Press the **<** or **>** button to adjust the level.

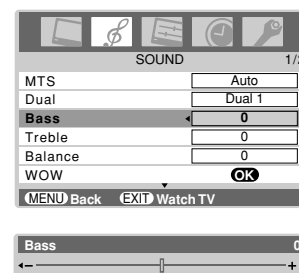

Selection	< Pressing	>
Bass	weaker	stronger
Treble	weaker	stronger
Balance	decreases the right channel	decreases the left channel

# Sound adjustment (continued)

## To select the audio output

Using the TV's features

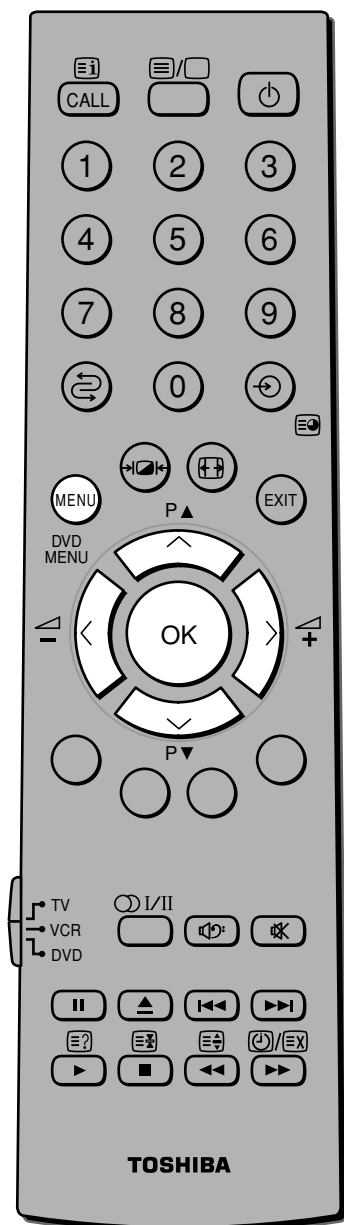

With the Audio output function "Variable", you can use the TV's remote controller to adjust the sound volume of the external audio system connected (see page 39).

### To select the sound volume from AUDIO OUT terminals:

- 1 Press the **MENU** button, then press the < or > button to display the SET UP menu.
- 2 Press the ∨ or ∧ button to select AV connection, then press the **OK** button to display the AV connection menu.
- 3 Press the ∨ or ∧ button to select Audio output, then press the < or > button to select Variable or Fixed.

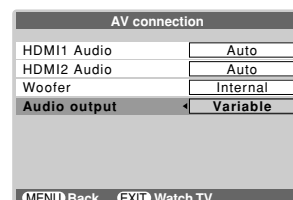
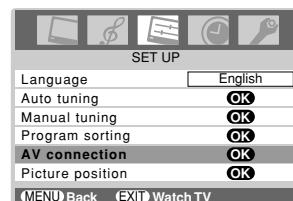

#### Note:

Make sure the volume control of your audio amplifier is set to a moderate listening level.

## To select the HDMI audio mode

You can select sound of the HDMI and DVI device audio connected terminals (see page 43) from three modes : Auto, Digital and Analogue.

- 1 Press the **MENU** button, then press the < or > button to display the SET UP menu.
- 2 Press the ∨ or ∧ button to select AV connection, then press the **OK** button to display the AV connection menu.
- 3 Press the ∨ or ∧ button to select HDMI 1 or HDMI 2, then press the ∨ or ∧ button to select Auto, Digital or Analogue.

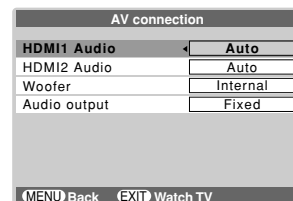
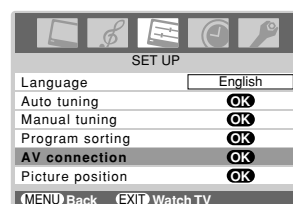

## To use the WOW surround sound

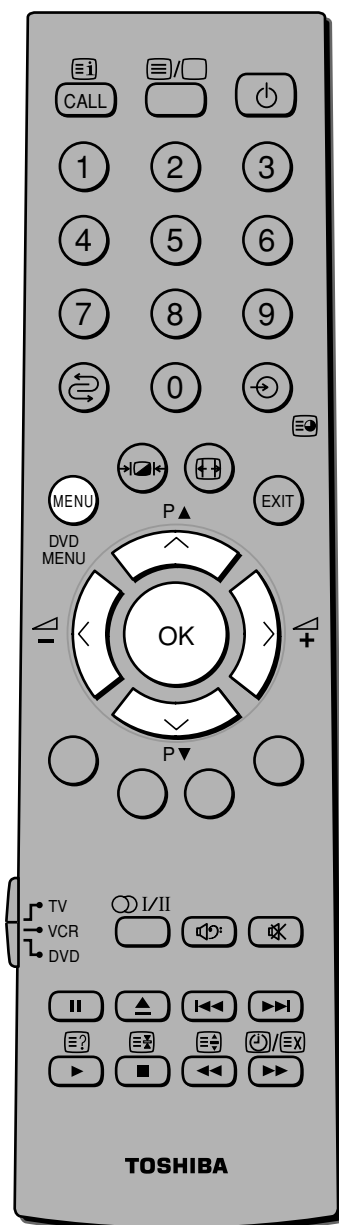

### Notes:

- If the broadcast is monaural, the SRS 3D effect does not work.
- WOW, SRS and  symbols are trademarks of SRS Labs, Inc.
- WOW technology is incorporated under license from SRS Labs, Inc.

WOW is a special combination of SRS Labs audio technologies that creates a thrilling surround experience with deep, rich bass from stereo sound sources. Your TV's audio will sound fuller, richer and wider.

- 1 Press the **MENU** button, then press the **<** or **>** button to display the SOUND menu.
- 2 Press the **∨** or **∧** button to select WOW, then press the **OK** button.
- 3 Press the **∨** or **∧** button to select an item you want to adjust, then press the **<** or **>** button to adjust the settings as required.

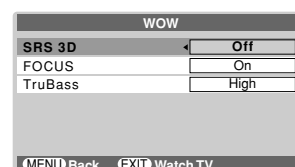
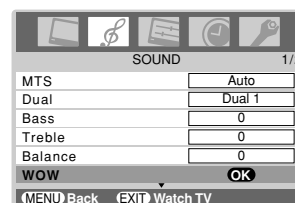

- SRS 3D: To turn On or Off the surround effect.
- FOCUS: To turn On or Off the surround effect.
- TruBass: To select your desired bass expansion level (Off, Low or High).

## To use the Stable sound

When the signal source is changed, the Stable sound function limits the high volume level to prevent extreme changes in volume. For example, this will prevent the sudden increase in volume that often happens when a TV program switches to a commercial.

- 1 From the SOUND menu, press the **∨** or **∧** button to select Stable sound on the 2nd page.
- 2 Press the **<** or **>** button to select On or Off.



## To activate/deactivate the speaker

Use this function to turn the TV speakers off when you connect an audio system (see page 39).

- 1 From the Sound menu, press the **∨** or **∧** button to select Speaker on the 2nd page.
- 2 Press the **<** or **>** button to select On or Off.



# Sound adjustment (continued)

## Woofer Internal/External mode, Bass boost, Woofer system

Using the TV's features

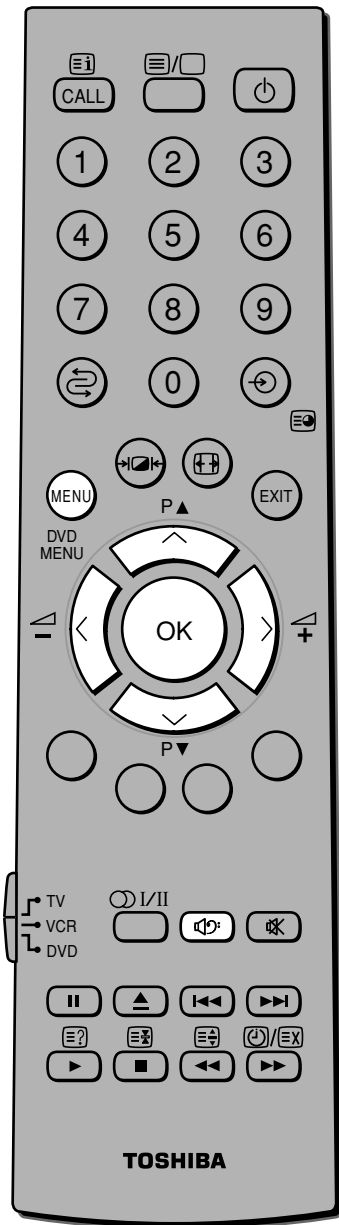

**Note:**  
The Bass Boost effect is active only when the sound outputs from the speaker or the external woofer system.

### To select the woofer Internal/External mode:

- 1 Press the **MENU** button, then press the < or > button to display the SET UP menu.
- 2 Press the ∨ or ∧ button to select AV connection, then press the **OK** button to display the AV connection menu.
- 3 Press the ∨ or ∧ button to select Woofer, then press the < or > button to select Internal or External.
  - Internal is to use the bass boost.
  - External is to use the external woofer system.

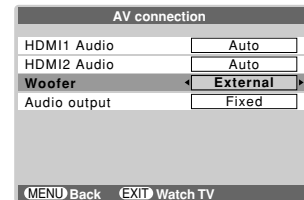

### To use the Bass boost:

- 1 Select Woofer Internal mode as shown above.
- 2 Press the button to display Bass boost level.
- 3 While the Bass boost display is on the screen, press the < or > button to adjust the Bass boost level.
- 4 To turn off the Bass boost, press the button to display Bass boost Off.



### To use the external woofer system:

- 1 Connect the external woofer to the "WOOFER" output terminal located on the rear of the TV (see page 39).
- 2 Select Woofer External mode from the AV connection menu.
- 3 Press the button to display External Woofer level, then press the < or > button to adjust the External Woofer level.
- 4 To turn off the External Woofer, press the button to display External Woofer Off.

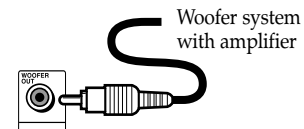

# Input source selection

## Input source selection

TV control panel

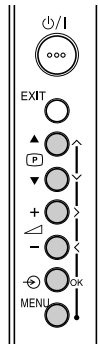

**Notes:**

- To return to the TV mode from the PC input mode, press the button.
- When the component video input HDMI 1, HDMI 2 or PC input mode is selected, the MONITOR output terminals (see page 39) output audio signal only.

**To select input source:**

**1** Press and hold the button or press the **OK** button on the remote control until the video input mode list appears on the screen, then press the or button to select appropriate input source (or press the button on the side panel or button on the remote control repeatedly to select required input source directly).

**OK:**

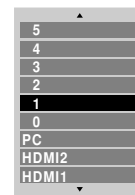

:

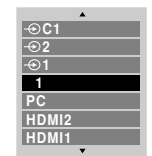

Ex. PC VGA mode



**2** Press the **OK** button.

- 1 ( (1), video 1 input),
- 2 ( (2), video 2 input),
- C1 ( (C1), COMPONENT VIDEO INPUT),
- C2 ( (C2), COMPONENT VIDEO INPUT),
- HDMI 1 ( HDMI 1 input),
- HDMI 2 ( HDMI 2 input),
- PC ( RGB/PC, PC input)

**Manual setting:**

**1** Press the **MENU** button, then press the or button to display the SET UP menu.

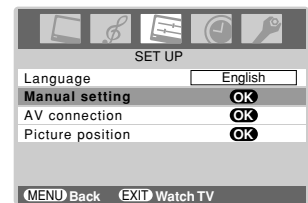

**2** Press the or button to select Manual setting, then press the **OK** button.

**3** Press the or button to select an item, then press the or button to select the item as shown below.

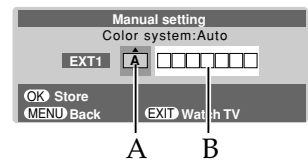

**A. Color System**  
Confirm that color system is set to "A" (Auto). If not, select "A" with the or button.

**B. Video label**  
The video label allows you to label each input source for your TV.

To change or create video labels:

1) Press the or button repeatedly to select a character for the first space, then press the button.

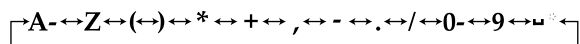

\*(blank space)

2) Repeat step 1) to enter the rest of the characters.  
If you would like a blank space in the label name, you must choose a blank space from the list of characters.

Press the **OK** button to store your settings.

# Timer, Blue screen, Auto format

## Timer

The Timer is especially useful if you want the TV to turn itself on or off after a selected period of time. Activation of the Timer is indicated by the orange "Ⓞ On-timer indicator", on the front of the TV (see page 10).

Using the TV's features

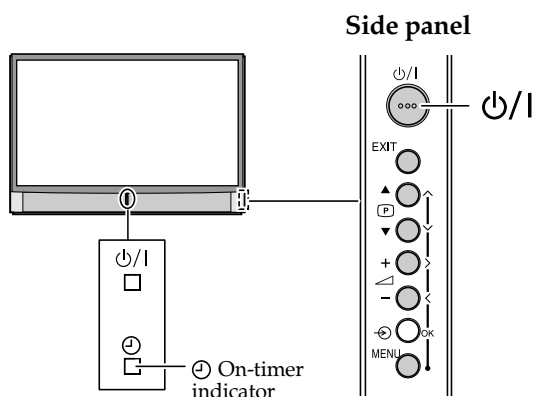

### To select the timer menu:

- 1 Press the **MENU** button, then press the < or > button to display the TIMER menu.
- 2 Press the ∨ or ∧ button to select the required timer mode (On timer or Sleep timer (Turn off the TV)).
- 3 Press the **Number** buttons (0-9), < or > button to set the On or Off delay time, e.g. on in 30 minutes and program 3 selected.
- 4 Press the **EXIT** button to exit the menu. When setting the On timer, press the ∨ or ∧ button to select the On timer Position and enter the program position number you want to watch. Set the Standby mode by pressing the Ⓞ button on the remote control or Ⓞ/I Power button on the TV control panel.

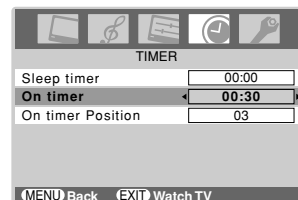

### Note:

The time display will set by 10 minutes, up to 12 hours 50 minutes.

### To activate Blue screen

With the Blue screen function On, the screen will automatically turn blue and the sound will be muted when no signal is being received.

- 1 Press the **MENU** button, then press the < or > button to display the FUNCTION menu.
- 2 Press the ∨ or ∧ button to select Blue screen.
- 3 Press the < or > button to select On or Off.

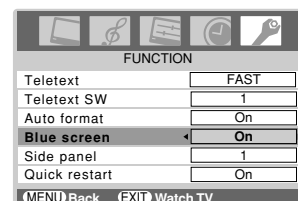

### Note:

In the PC input mode (see page 31), the Blue screen is not available.

### To use the Auto format

When the TV receives a true HDMI picture and the Auto format is On, it will automatically be displayed in HDMI format, irrespective of the TV's previous setting.

- 1 From the FUNCTION menu, press the ∨ or ∧ button to select Auto format.
- 2 Press the ∨ or ∧ button to select On or Off.

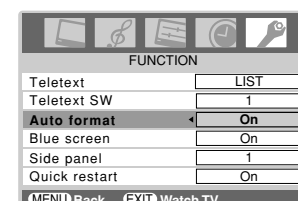



# Side panel adjustment, Quick restart

## Side panel adjustment

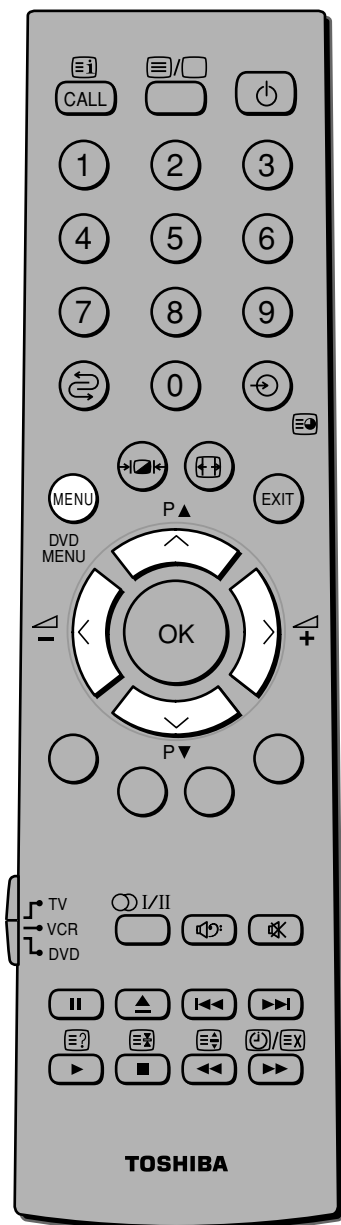

You can adjust the brightness of side panel in 14:9 or 4:3 mode.

### To adjust the Side panel setting:

- 1 Press the **MENU** button, then press the < or > button to display the FUNCTION menu.
- 2 Press the ∨ or ∧ button to select Side panel.
- 3 Press the < or > button to adjust the settings as required.

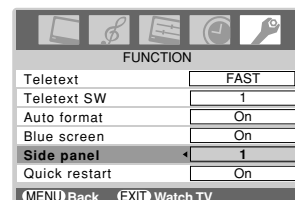

## Setting the Quick restart feature

With the Quick restart feature set to ON, the TV will stay in Shutdown mode for several minutes after the TV is turned off (see Note below).

If the TV is turned on from Shutdown mode, the full picture appears immediately.

### To set the Quick restart:

- 1 Press the **MENU** button, then press the < or > button to display the FUNCTION menu.
- 2 Press the ∨ or ∧ button to select Quick restart, then press the < or > button to select On or Off.

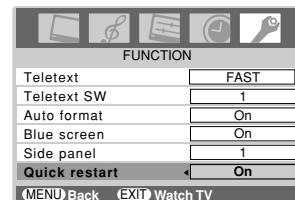

#### Note:

If Quick restart is set to Off and you turn off the TV, it can take several seconds for the picture to appear when you turn on the TV again.

If Quick restart is set to On and you turn off the TV, the following will occur for a few minutes:

- The screen (lamp) lights dimly.
- The fans continue to run.

This is a function of the Quick restart Shutdown mode and is not a TV malfunction. If you do not prefer this, set the Quick restart feature to Off.

When the Quick restart feature is set to Off, if you repeatedly turn the TV on and off in a short period of time, the useful service life of the lamp may be shorter than the average useful service life.

# Teletext - Setting up

- This TV has a multi-page teletext memory, which takes a few moments to load and it offers two ways of viewing Teletext FAST and LIST which are explained on page 36.

## Teletext mode

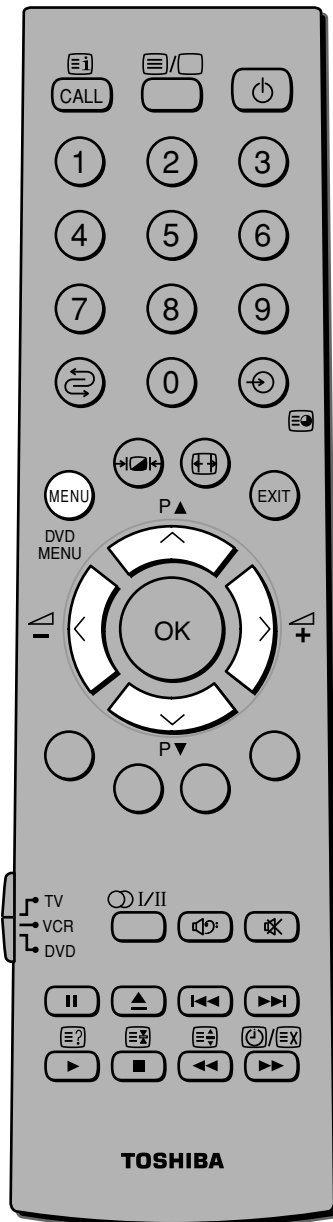

Viewing teletext

### To select Teletext mode:

Select a channel position with the desired teletext service.

**1** Press the **MENU** button, then press the < or > button to display the FUNCTION menu.

**2** Press the ∨ or ∧ button to select Teletext.

**3** Press the < or > button to select FAST or LIST mode.

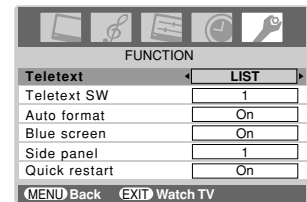

### Note:

When you are watching the teletext program, SET UP menu and FUNCTION menu are not selectable.

# About Teletext

## Teletext general information

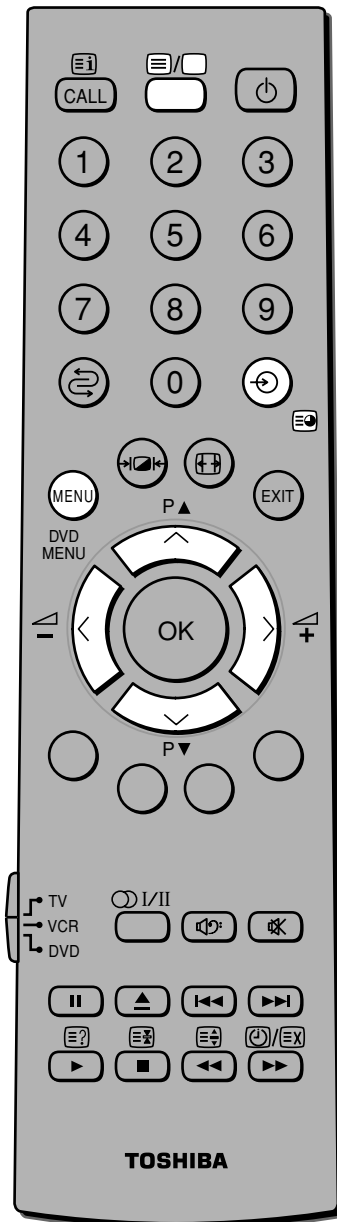

### button:

Pressing the  button once will bring up the teletext screen. Press again to superimpose the teletext over a normal broadcast picture. Press again to return to normal TV mode. You need to return to normal viewing if you wish to change channels.

When you first press the  button to access the text service, the first page you see will be the initial page.

In **FAST** mode, this displays the main subjects available and their relevant page numbers.

In **LIST** mode, you will see the page numbers currently stored on the **each color** button.

### Sub-pages:

Once in this chosen page, if there are sub-pages they will automatically load into memory without changing the one you are reading. If there are many sub-pages, it will take a long time for them all to load and this will depend on the speed with which the broadcaster transmits them.

**To access the sub-pages in memory, press the  ( - ) button, then use the ^ and v buttons to view them.**

## Teletext SW adjustment

If reception is weak, the picture may appear blurred, and text may not appear clearly on the screen. In this case, use this function to make text appear clearer.

- 1 Press the **MENU** button, then press the < or > button to display the **FUNCTION** menu.

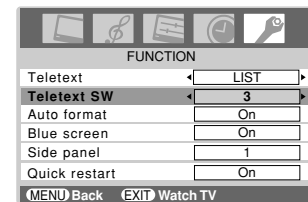

- 2 Press the v or ^ button to select **Teletext SW**, then press the < or > button to adjust 1, 2 or 3 modes.

### Notes:

- This function may not be available in some cases.
- This function is available only in the antenna input signal mode.

# Teletext – FAST and LIST modes

## Using FAST mode

There are two Modes: FAST will display FASTEXT, if available. LIST will display your four favorite pages. In either mode, as an alternative to the colored buttons, you can access a page by entering a 3-digit number, using the **Number** buttons on the remote control, or to advance to the next page, press the **P▲** (^) button, to go back to the previous page press the **P▼** (v) button.

To change between FAST and LIST, see page 34.

Press the  button to access teletext.

If FASTEXT is available, you will see 4 colored titles at the base of the TV screen. To access any given subject, simply press the relevant colored button on the remote control.

If FASTEXT is not available, you can access any page simply by entering a 3-digit page number or pressing the corresponding colored button.

For further information on your particular text system(s), see the broadcast teletext index page or consult your local Toshiba dealer.

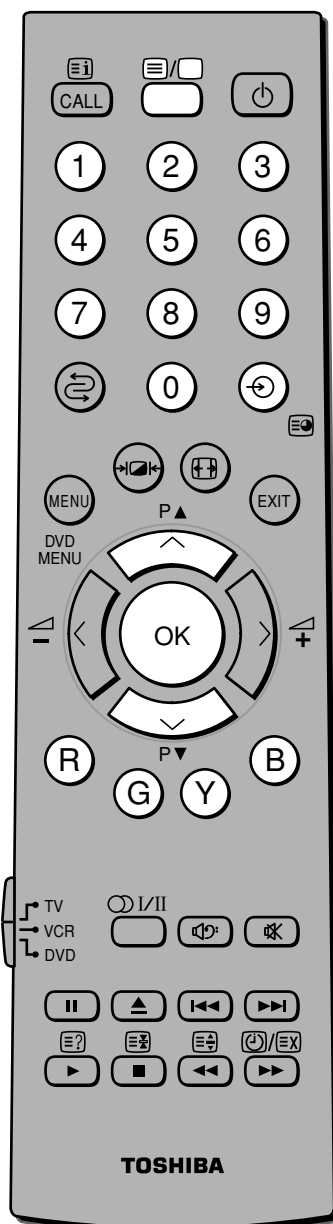
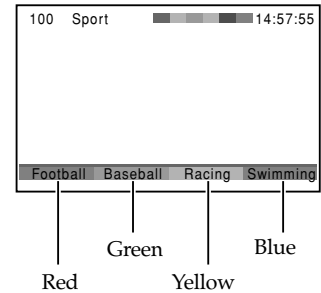

## Using LIST mode

- 1 Press the  button to access teletext.

The four choices at the bottom of the screen are now number – 100, 200, 300 and 400, which have been programmed into the TV's memory.

- 2 To view these pages, use the colored prompt buttons.  
e.g. press the Green button to view page 200.

- 3 If you want to change these stored pages, press the colored button for the color you want to change.  
e.g. Press the Green button and enter the 3-digit number.

This number will change in the top left of the screen and in the colored highlight.

- 4 Press the **OK** button to store your choice. The bars at the bottom of the screen will flash white.

- 5 You may view other pages by simply entering the 3-digit page number – but **DO NOT** press the **OK** button or you will lose the favorite already stored.

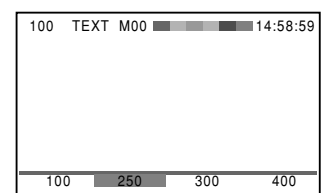
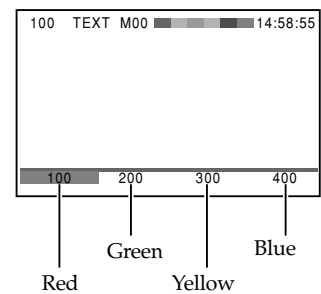

# Teletext - Control buttons

- Below is an introduction to the teletext buttons on your remote control and their functions.

## Teletext buttons on the remote control

### Note:

It will not be possible to change program position while in Teletext mode, you will have to cancel the teletext first by pressing the  button to return to a normal TV picture.

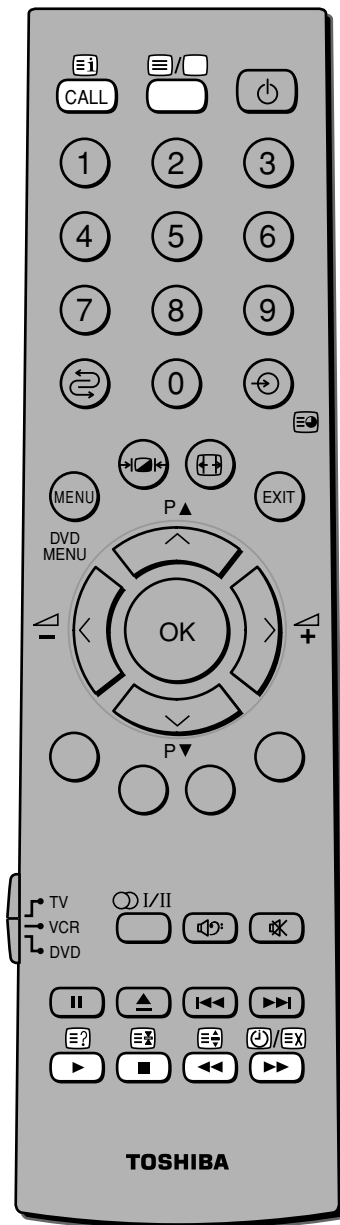

### To display a page of teletext:

Press the  button to display teletext. Press again to superimpose the teletext over a normal broadcast picture. Press again to return to normal TV mode.

### To display an index/initial page:

#### In FAST-mode

Press the  button to access the index page. The one displayed is dependant on the broadcaster.

#### In LIST-mode

Press the  button to return to the 100 page or initial page.

### To reveal concealed text:

Some pages cover topics such as quizzes and jokes. To discover the solutions, press the  button.



### To hold a wanted page:

This function is included as it is part of the broadcast teletext system but you will not need it as this TV allows you to control the display of sub-pages.

### To enlarge the teletext display size:

Press the  button once to enlarge the top half of the page, press again to enlarge the bottom half of the page. Press again to revert to the normal size.

### To select a page while viewing a normal picture:

When in teletext mode, if a page selection is made and then the  button is pressed, a normal picture will be displayed. The TV will indicate when the page is present by displaying the title bar of the text page at the top of the screen. Press the  button to view the page.

### To select the time display:

If you press the  button while watching a normal TV broadcast, you will see a time display from the broadcaster. It will remain on the screen for about 5 seconds.

9:56 and 25 seconds p.m.

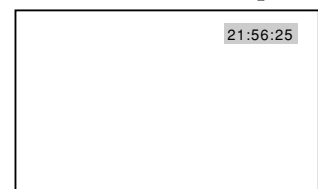

# Side connections

- You can connect a wide variety of auxiliary equipment via the terminals located on the right side of the TV  $\text{Ⓢ}$  (2).

## Connection example

Please always refer to the owner's manual of the equipment to be connected for full details.

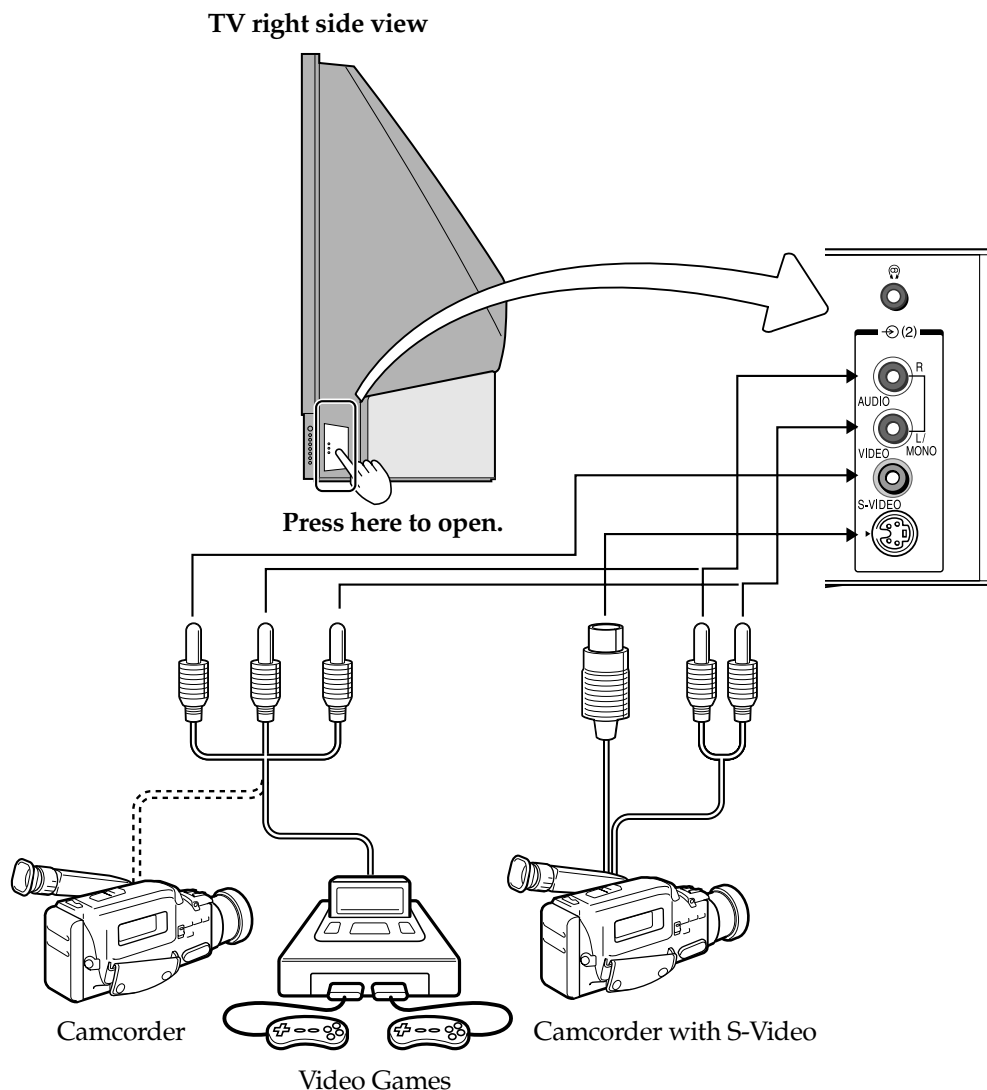

- To select the side inputs, press and hold the  $\text{Ⓢ}$  button until the video input mode list appears on the screen, then press the  $\wedge$  or  $\vee$  button to select  $\text{Ⓢ}$  2 (see page 31), then press **OK**.
- Before connecting any external equipment, turn off all main power switches.
- Connect either the S-VIDEO input terminal or VIDEO input terminal, whichever terminal is used. Never connect to both of these terminals.
- If you connect mono sound equipment to  $\text{Ⓢ}$  (2), connect the audio output of the equipment to the L/MONO jack on the TV.

# Back connections

## Connection example

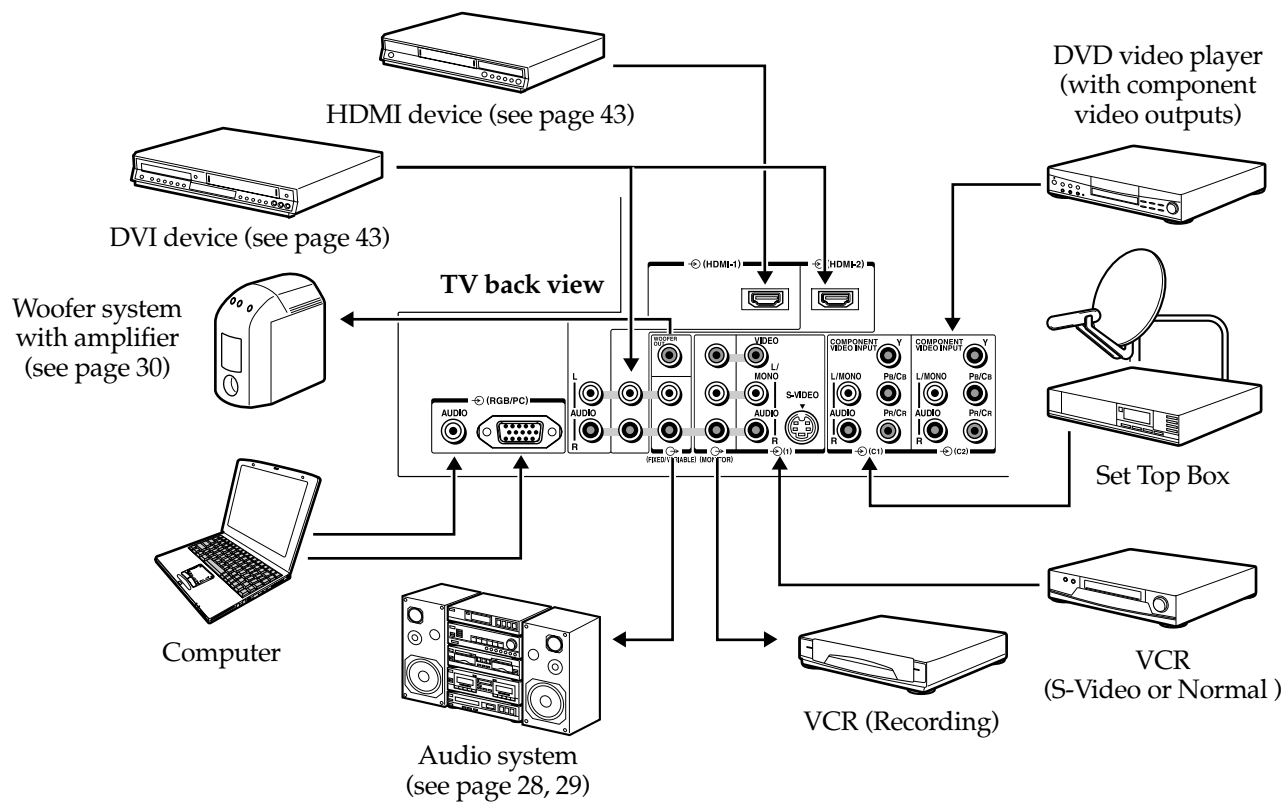

- Before connecting any external equipment, turn off the TV.
- The unauthorized recording of television programs, video tapes and other materials may infringe upon the provisions of copyright laws.
- Connect either the S-VIDEO input terminal or VIDEO input terminal, whichever terminal is used. Never connect to both of these terminals.
- In addition, there is a fixed/variable external audio output which enables the connection of a suitable audio system. A 3.5 mm switched phono socket allows an external active Woofer system to be connected.
- The COMPONENT VIDEO INPUT consists of three component video jacks (Y, Pb/Cb, Pr/Cr) and provides the best picture performance. These jacks can only be used with the component video compatible equipment, e.g. DVD video player etc.
- Two HDMI (High-Definition Multimedia Interface) inputs receive digital audio and uncompressed digital video from an HDMI device or uncompressed digital video from a DVI device.
- Additional equipment and cables shown are not supplied with this TV.

# Connecting a computer (PC)

- An analog RGB (15 pin) computer cable can be connected.

## To connect a computer

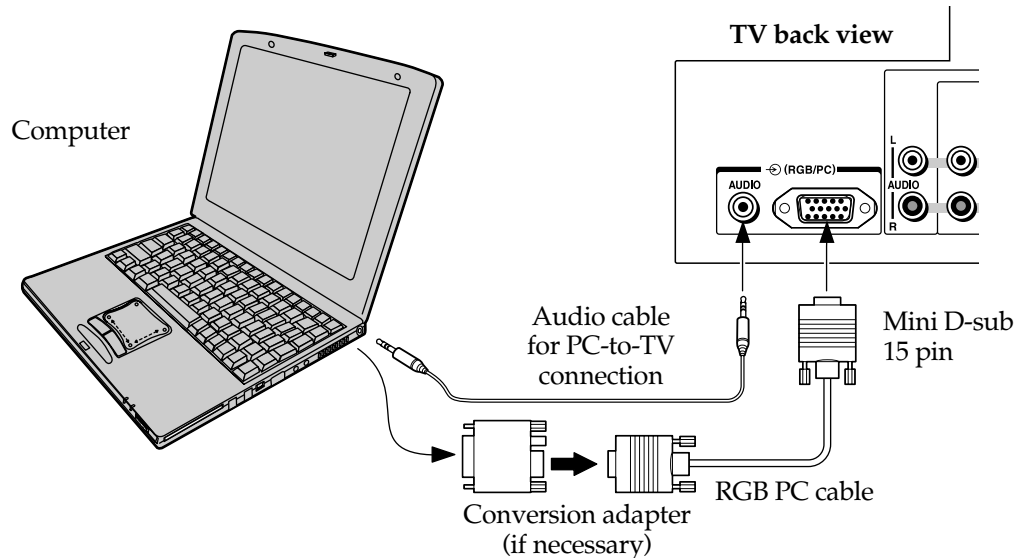

Connect a PC cable from the computer to the RGB/PC terminal on the back of the TV.

**The following signals can be displayed:**

- VGA: VESA 640 x 480 @ 60 Hz
- SVGA: VESA 800 x 600 @ 60 Hz
- XGA: VESA 1024 x 768 @ 60 Hz

**Notes:**

- Some PC models cannot be connected to this TV.
- There is no need to use an adapter for computers with DOS/V compatible mini D-sub 15 pin terminal.
- A bar may appear in the upper, lower, right or left side of the screen, or parts of the picture may be obscured depending on some signals. This is not the malfunction.
- If the edges of the picture are stretched, readjust the picture position adjustment in the PC Setting menu.
- Depending on the specification of the PC you are playing the DVD-Video on, and the DVD's title, some scenes may be skipped, or you may not be able to pause during multi-angle scenes.

**Signal names for mini D-sub 15 pin connector**

Pin No.	Signal name	Pin No.	Signal name
1	R	9	NC
2	G	10	Ground
3	B	11	NC
4	NC (not connected)	12	NC
5	NC	13	H-sync
6	Ground	14	V-sync
7	Ground	15	NC
8	Ground		

Pin assignment for RGB/PC terminal



# PC setting

- In the PC input mode, you cannot select the Color, Tint, Black stretch, MPEG NR and DNR in the Picture setting menu and Cinema mode (see page 14).
- In the PC input mode, the Manual setting (see page 31) is not displayed.

## To adjust a PC setting

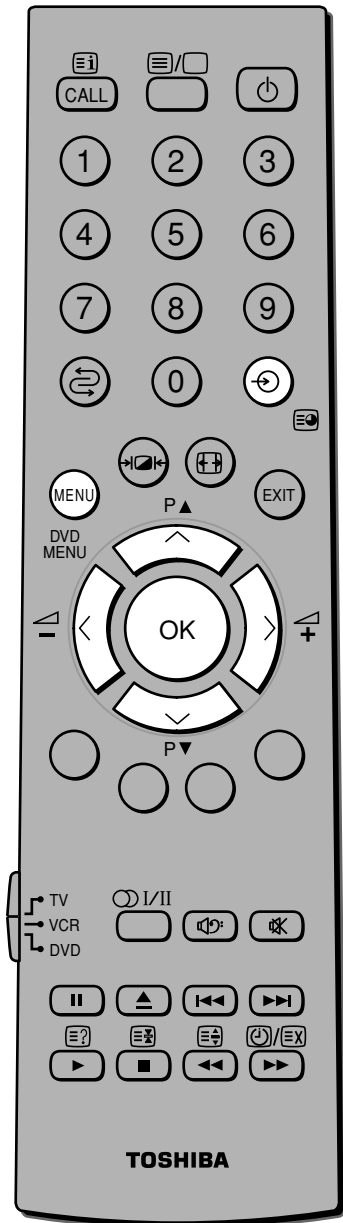

First press and hold the button until the video input mode list appears on the screen, then press the or and **OK** buttons in order to select the PC input mode (see page 31).

### To adjust the Picture size/position:

**1** Press the **MENU** button, then press the or button to display the SET UP menu.

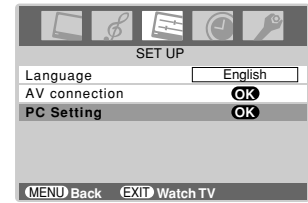

**2** Press the or button to select PC Setting.

**3** Press the **OK** button to display the PC Setting menu.

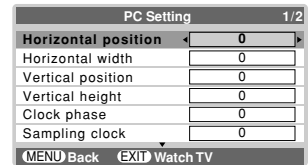

**4** Press the or button to select an option you want to adjust. (Picture size/position menu: Horizontal position, Horizontal width, Vertical position and Vertical height)

**5** Press the or button to adjust the settings as required.



# PC setting (continued)

- If the clock phase, which synchronizes the PC signal and TV display, is not optimized, the picture will blur. This function enables you to adjust clock phase and display a clear picture.
- If the sampling clock does not synchronize with the dot clock frequency of the PC, blurred picture detail will occur, or screen width will change, or drift patterns in vertical lines may be apparent. This function enables you to adjust it and optimize the picture.
- The Reset function adjusts the PC Setting to the factory settings.

## To adjust a PC setting (continued)

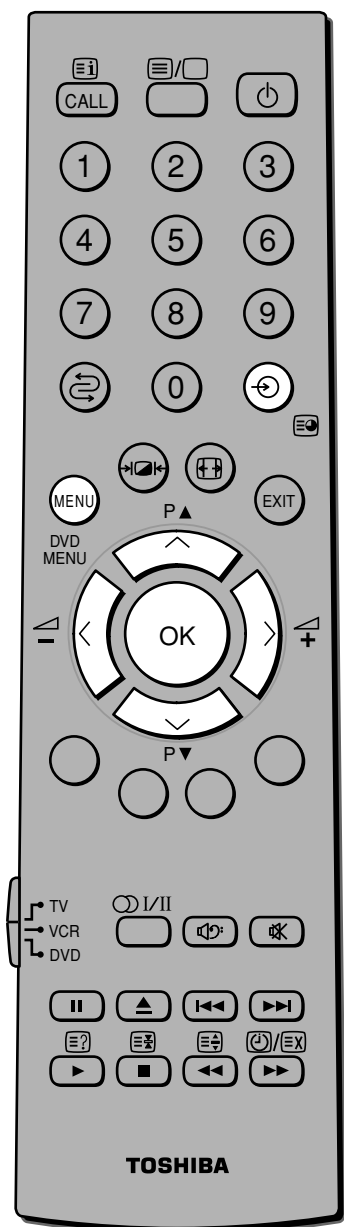

First press and hold the button until the video input mode list appears on the screen, then press the  $\downarrow$  or  $\uparrow$  and **OK** buttons in order to select the PC input mode (see page 31).

### To adjust the Clock phase of the picture:

- 1 Press the **MENU** button, then press the  $\leftarrow$  or  $\rightarrow$  button to display the SET UP menu. Press the  $\downarrow$  or  $\uparrow$  button to select PC Setting.



- 2 Press the **OK** button, then press the  $\downarrow$  or  $\uparrow$  button to select Clock phase.

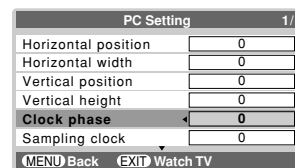

- 3 Press the  $\leftarrow$  or  $\rightarrow$  button to obtain a clear picture.



### To adjust the Sampling clock:

- 1 From the PC Setting menu, press the  $\downarrow$  or  $\uparrow$  button to select Sampling clock.
- 2 Press the  $\leftarrow$  or  $\rightarrow$  button to optimize the picture.

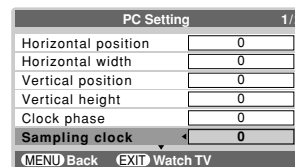

### To reset the PC Setting:

- 1 From the PC Setting menu, press the  $\downarrow$  or  $\uparrow$  button to select Reset on the 2nd page.
- 2 Press the **OK** button.

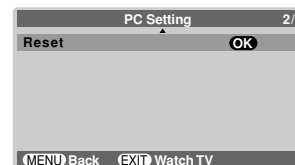

**Note:**

The optimum points of the clock phase and sampling clock adjustments may be incomprehensible according to the input signals.

# Connecting an HDMI and a DVI device

- This TV is not intended for connection to and should not be used with a PC.
- When turning on your electronic components, turn on the TV first, and then the HDMI or DVI device.
- When turning off your electronic components, turn off the HDMI and DVI device first, and then the TV.
- This model may not be compatible with features and/or specifications that may be added in the future.

## To connect an HDMI and a DVI device

The HDMI input on your TV receives digital audio and uncompressed digital video from an HDMI device and uncompressed digital video from a DVI device.

This input is designed to accept HDCP program material in digital from EIA/CEA-861/861B compliant consumer electronic devices (such as a set top box and DVD player with HDMI and DVI output).

The HDMI input is designed for best performance with 1080i (50 Hz/60 Hz) high-definition video signals, but will also accept and display 480i, 480p, 576i, 576p and 720p (50 Hz) signals.

- HDMI: High-Definition Multimedia Interface
- DVI: Digital Video Interface
- HDCP: High-bandwidth Digital Content Protection
- EIA/CEA-861/861B compliance covers the transmission of uncompressed digital video with high-bandwidth digital content protection, which is being standardized for reception of high-definition video signals. Because this is an evolving technology, it is possible that some devices may not operate properly with the TV.

**Note:**

DO NOT CONNECT A PC USING THE HDMI PORT. ALWAYS use the VGA port provided to connect a PC.

**To connect an HDMI device:**  
One HDMI cable (type A connector)

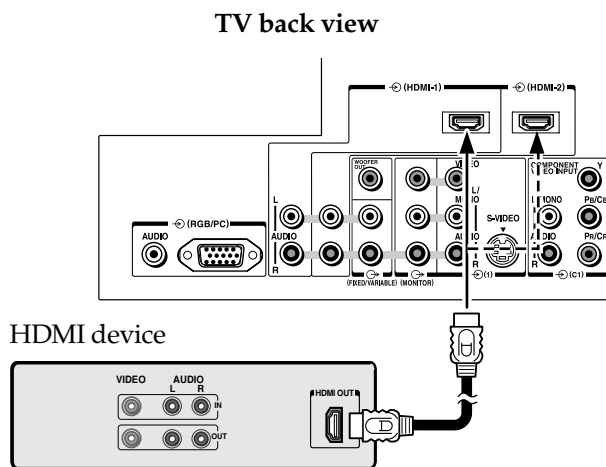

For proper operation, it is recommended that you use a short HDMI cable. HDMI cable transfers both video and audio. Separate analog audio cables are not required. Some CDVs (video CDs) may not output digital audio signals. In that case, you may hear sound by connecting analog audio cables.

**To connect a DVI device:**  
One HDMI (type A connector)-to-DVI adapter cable and audio cables

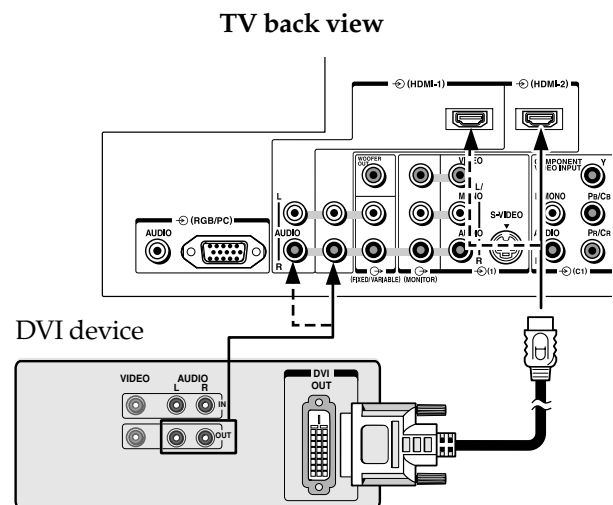

**HDMI (type A connector)-to-DVI adapter cable**  
For proper operation, the length of an HDMI-to-DVI adapter cable should not exceed 3m. The recommended length is 2m.

**Standard analog audio cables**  
An HDMI-to-DVI adapter cable transfers only video. Separate analog audio cables are required.

- HDMI, the HDMI logo, and High-Definition Multimedia Interface are trademarks or registered trademarks of HDMI Licensing, LLC.

# Troubleshooting

- Before calling a service technician, please check the following table for a possible cause of the symptom and some solutions.

## Symptom and solution

Symptom	Solution
TV will not turn on	<ul style="list-style-type: none"> <li>• Make sure the power cord is plugged in, then press <b>⏻/I</b>.</li> <li>• The remote control batteries may be dead. Replace the batteries.</li> <li>• The lamp unit may need to be replaced (page 8). Also see "LED indications" on page 45.</li> </ul>
No picture, no sound	<ul style="list-style-type: none"> <li>• Check the antenna connections.</li> </ul>
No sound, picture OK	<ul style="list-style-type: none"> <li>• The sound may be muted. Press <b>⏮ +</b>, <b>⏭ -</b> or <b>⏸</b>.</li> <li>• The station may have broadcast difficulties. Try another channel.</li> <li>• Check that the Speaker function in SOUND menu is properly set.</li> </ul>
Poor sound, picture OK	<ul style="list-style-type: none"> <li>• The station may have broadcast difficulties. Try another channel.</li> </ul>
Poor picture, sound OK	<ul style="list-style-type: none"> <li>• Check the antenna connections.</li> <li>• The station may have broadcast difficulties. Try another channel.</li> <li>• Adjust the PICTURE menu.</li> </ul>
Poor reception of broadcast channels	<ul style="list-style-type: none"> <li>• Check the antenna connections.</li> <li>• The station may have broadcast difficulties. Try another channel.</li> <li>• Make sure the Color system is properly set.</li> </ul>
Teletext problems	<ul style="list-style-type: none"> <li>• Check the antenna connections.</li> </ul> <p>Good performance of text depends on a good strong broadcast signal.</p>
Multiple images	<ul style="list-style-type: none"> <li>• The station may have broadcast difficulties. Try another channel.</li> <li>• Antenna reception may be poor. Use a high directional outdoor antenna.</li> <li>• Check if the direction of the antenna has changed.</li> </ul>
Poor color or no color	<ul style="list-style-type: none"> <li>• The station may have broadcast difficulties. Try another channel.</li> <li>• Adjust the Tint and/or Color in the PICTURE menu.</li> </ul>
No picture or too dark	<ul style="list-style-type: none"> <li>• The lamp unit may need to be replaced (page 8).</li> </ul>
The remote control does not operate	<ul style="list-style-type: none"> <li>• Remove all obstructions between the remote control and the remote control sensor in the TV.</li> <li>• The remote control batteries may be dead. Replace them with new ones.</li> <li>• Check that the TV/VCR/DVD switch on the remote control is properly set.</li> </ul>

## LED indications

The orange and blue LEDs on the TV (at the bottom center of the TV) indicate the TV's status, as described below.

- Blue ON (solid) and Orange OFF = The TV power cord is plugged in.
- Orange ON (solid) and Blue OFF = The On timer is operating.
- Orange and/or Blue blinking (see table below).

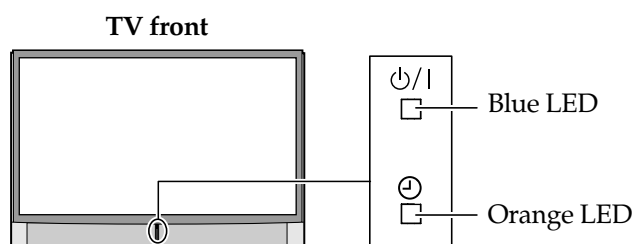

LED Indication	Condition	Solution
1) <b>Orange blinks</b> continuously at 3-second intervals. <b>Blue blinks</b> continuously at 0.5-second intervals.	The lamp unit door is not seated properly.	Turn OFF the TV and unplug the power cord. Review "How to replace the lamp unit" on page 47 to ensure that the lamp door is installed securely. If the problem persists, contact a Toshiba Authorized Service Center.
2) <b>Orange blinks</b> continuously at 0.5-second intervals; <b>Blue is ON</b> (solid).	The lamp is not working properly.	The TV will automatically try to restart itself eight times (see item #3).
3) <b>Orange and Blue blink</b> continuously at 1-second intervals.	The lamp is not working properly after the eighth automatic restart (see item #2).	Turn the TV OFF and then ON again. If the problem persists, replace the lamp unit (see pages 46–47). If the problem still exists, contact a Toshiba Authorized Service Center.
4) <b>Orange is OFF;</b> <b>Blue blinks</b> at 0.2-second intervals 4 times (repeat).	An abnormal temperature increase has occurred.	Turn OFF the TV. Check to make sure all slots and openings in the TV cabinet are not covered, blocked, or dusty. Turn ON the TV again. If the problem persists, contact a Toshiba Authorized Service Center.
5) <b>Orange is OFF;</b> <b>Blue blinks</b> continuously at 0.5-second intervals.	Abnormal operation (including cooling fan stop).	Turn OFF the TV and unplug the power cord. Plug the power cord in again and turn ON the TV. If the problem persists, contact a Toshiba Authorized Service Center.
6) <b>Orange is OFF;</b> <b>Blue blinks</b> continuously at 1-second intervals.	Abnormal operation of BUS line.	Turn OFF the TV and unplug the power cord. Plug the power cord in again and turn ON the TV. If the problem persists, contact a Toshiba Authorized Service Center.
7) <b>Orange is OFF;</b> <b>Blue blinks</b> at 0.2-second intervals 3 times (repeat).	The color wheel has stopped.	Turn OFF the TV and unplug the power cord. Plug the power cord in again and turn ON the TV. If the problem persists, contact a Toshiba Authorized Service Center.

# Lamp unit replacement

The light source for this TV is a projection lamp unit with a limited service life. When the lamp wears out, the picture may become dark or black, or the lamp may fail, at which time you must replace the lamp unit. The length of service life varies depending on product use and user settings. See "Selecting the lamp mode" on page 25 for information on switching the lamp mode.

## Replacing the lamp unit

**WARNING: TO REDUCE THE RISK OF ELECTRIC SHOCK, DO NOT REMOVE TV COVERS. NO USER-SERVICEABLE PARTS INSIDE. REFER SERVICING TO QUALIFIED SERVICE PERSONNEL.**

### When to replace the lamp unit

If you try to replace the lamp unit by yourself, read these instructions carefully.

### You should replace the lamp unit:

- if the picture darkens and/or colors fade;
- if the screen (lamp) does not light (LED indication #3, page 45); or
- if you hear a loud noise and the picture goes black, which may indicate a lamp rupture (LED indication #3, page 45).

**Only the replacement lamp unit model listed below can be used with this TV.**

**Using any other lamp may cause damage to the TV and/or lamp.**

**Model No.: D95-LMA ( Stock No. 23311168)**

### Important information

- NEVER look directly at the lamp when lit as eye damage could result. ALWAYS turn off the TV by unplugging the power cord before opening the lamp unit door and DO NOT remove the back cover of the TV.

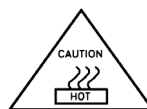

- **The temperature of the lamp immediately after use exceeds 200°C. Allow the lamp to cool for at least 1 hour before replacing it, touching it before it has cooled will result in severe burns.**

- When replacing the lamp unit ALWAYS wear gloves to reduce the risk of burns.
- The lamp unit door is provided with an interlock to reduce the risk of electric shock and excessive ultraviolet radiation.
- DO NOT attempt to replace the lamp unit without removing the lamp unit door completely, failure to do so could result in serious injury or death.
- If the lamp unit glass is accidentally touched or gets dirt on it, it can be gently wiped clean with a lint-free cleaning cloth such as a camera lens cloth or spectacles cloth. NEVER clean the lamp with any type of flammable or aerosol cleaning liquid. Most household cleaning agents contain chemicals that are flammable at high temperatures.
- The lamp unit contains mercury. Disposal of mercury may be regulated due to environmental considerations. Dispose of the used lamp unit by the approved method for your area. For disposal or recycling information, please contact your local authorities.

## How to replace the lamp unit

- 1** Turn off the TV and remove the power plug from the wall outlet.

**Allow the lamp to cool for at least 1 hour before replacing it.**

- 2** On the lamp unit door on the side of the TV, loosen the screw using a manual screwdriver, and then remove the lamp unit door.

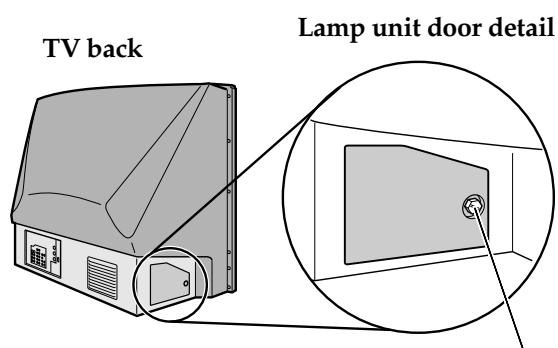

Loosen screw using manual screwdriver

- 3** Using a manual screwdriver, loosen the two screws on the lamp unit.

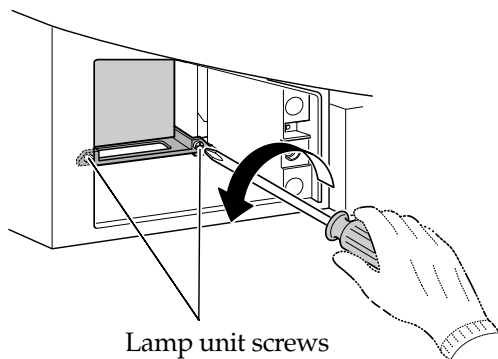

Lamp unit screws

- 4** Grasp the lamp unit handle and gently pull the lamp unit straight out of the TV. Set the old lamp unit aside.

**Remember to wear lint-free gloves when replacing the lamp unit.**

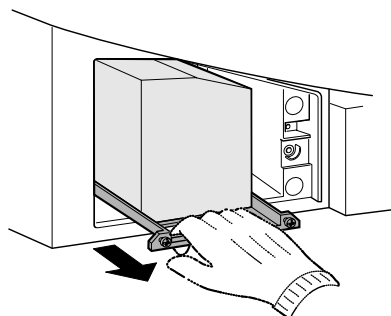

**Note:**  
Wear soft, lint-free gloves when replacing the lamp unit.

- 5** Carefully insert the new lamp unit straight into the TV until it is fully seated.

**Notes:**

- Never subject the lamp unit to excessive shock.
- Never touch the lamp unit glass or otherwise get it dirty. Doing so may affect the image quality and reduce the service life of the lamp.

- 6** Using the manual screwdriver tighten the two screws. Make sure that the screws are hand-tight only, do not use an electric screwdriver to avoid over-tightening.

- 7** Reattach the lamp unit door, making sure to insert the hooks on the left side of the lamp unit door inside the opening in the TV cabinet.

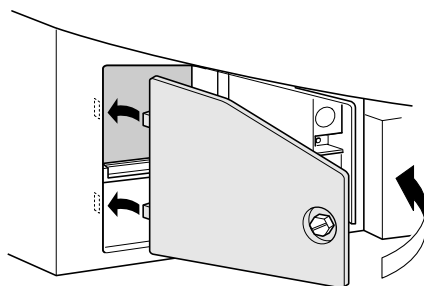

Lamp unit door

- 8** Replace the screw and hand-tighten using a manual screwdriver.

- 9** Plug in the power cord and turn on the TV. After the initial warm up period (which may take several seconds for full picture brightness), the TV should now operate normally.

If there is no picture, the picture is very dark or the TV does not turn on, turn it back off and remove the power plug from the wall outlet. Repeat steps 1 to 7 to ensure that the lamp unit has been installed correctly.

Put the old lamp into the now empty lamp unit box and dispose of it according to local Government guidelines. Make sure it is out of reach of children and animals.

If you require further assistance, contact the nearest Toshiba Authorized Service Center or dealer.

# Broadcast system, Specifications

## Broadcast transmission systems of each country or region

Area	Country or Region	System	
		Color	Sound
Asia M. E.	Bahrain, Kuwait, Israel, Oman, Qatar, United Arab Emirates, Yemen, etc. Indonesia, Malaysia, Singapore, Thailand, etc.	PAL	B/G
	China	PAL	D/K
	China Hong Kong	PAL	I
	Iraq, Islamic Republic of Iran, Lebanon, Saudi Arabia, etc.	SECAM	B/G
	Russian Federation, etc.	SECAM	D/K
	Myanmar, etc.	NTSC	M
Oceania	Australia, New Zealand, etc.	PAL	B/G
Africa	Republic of South Africa, etc.	PAL	I
South America	Argentina, Paraguay, Uruguay, etc.	PAL	N
	Brazil	PAL	M
	Chile, Colombia, etc.	NTSC	M

**Note:**

PAL, SECAM and NTSC 3.58 (MHz) are different color signal broadcast transmission systems applicable to different countries or region. NTSC 4.43 (MHz) is used in special VCRs to playback NTSC recorded video tapes through PAL television equipment.

## Specifications

Model	62CM9UA/62CM9UE/72CM9UA/72CM9UE		
Power source	220V - 240V AC, 50 Hz		
Power consumption	265W, 0.9W (standby)		
Dimensions	62CM9UA/62CM9UE: 1,450mm (W) 475mm (D) 994mm (H) 72CM9UA/72CM9UE: 1,672mm (W) 550mm (D) 1,119mm (H)		
Mass (Weight)	62CM9UA/62CM9UE: 49.5kg, 72CM9UA/72CM9UE: 58.5kg		
Television system (Antenna input)	Channel coverage:		
	PAL	B/G (CCIR)	VHF 2 - 12 UHF 21 - 69 CATV X - Z+2, S1 - S41
	PAL	I (UK)	VHF - UHF 21 - 69 CATV -
	PAL	D/K (CHINA)	VHF 1 - 12 UHF 13 - 57 CATV Z1 - Z38
	SECAM	B/G (CCIR)	VHF 2 - 12 UHF 21 - 69 CATV X - Z+2, S1 - S41
	SECAM	D/K (OIRT)	VHF 1 - 12 UHF 21 - 69 CATV X1 - X19
	NTSC	M (US)	VHF 2 - 13 UHF 14 - 69 CATV A6 - A1, A - W, AA - ZZ, AAA, BBB
	NTSC	M (JAPAN)	VHF 1 - 12 UHF 13 - 62 CATV M1 - M10, S1 - S41
	Special RF signal:		
	NTSC 4.43 color system	5.5/6.0/6.5 MHz sound system	
	PAL 60 Hz color system	5.5/6.0/6.5 MHz sound system	



## Specifications (continued)

COMPONENT VIDEO INPUT terminals (the signal format)	480i, 480p, 576i, 576p, 720p (50/60 Hz), 1080i (50/60 Hz)		
Color system	PAL, SECAM, NTSC 3.58/4.43		
Aspect ratio	16 : 9		
Visible size (diagonal)	62CM9UA/62CM9UE: 1,575 mm 72CM9UA/72CM9UE: 1,829 mm		
Audio power	15 W + 15 W (10% THD)		
Speakers	120 mm (round) 4pcs.		
Input/Output terminals	⊖ (1) Input	4 pin Phono jacks	S-video A/V
	⊖ (2) Input	4 pin Phono jacks	S-video A/V
	⊖ (C1) Input	Component video Phono jacks	Y, P <sub>B</sub> /C <sub>B</sub> , P <sub>R</sub> /C <sub>R</sub> Audio L/Mono + R
	⊖ (C2) Input	Component video Phono jacks	Y, P <sub>B</sub> /C <sub>B</sub> , P <sub>R</sub> /C <sub>R</sub> Audio L/Mono + R
	⊕ MONITOR Output	Phono jacks	A/V
	⊕ AUDIO OUT Output	Phono jacks	Audio L + R (Fixed/Variable)
	⊕ Woofer Output	Phono jack	Bass Line out (Variable)
	⊖ RGB/PC Input	Mini D-sub 15 pin	Analog RGB
	⊖ AUDIO Input	3.5 mm stereo mini jack	
	⊖ HDMI 1 Input (type A)	19pin	A/V Digital
	⊖ HDMI (AUDIO) 1 Input	Phono jacks	Analog L+R
	⊖ HDMI 2 Input (type A)	19pin	A/V Digital
	⊖ HDMI (AUDIO) 2 Input	Phono jacks	Analog L+R
	Headphones jack	3.5 mm (Diameter) stereo	
Supplied accessories	Owner's manual (1), Remote control (1), Batteries (2)		
Optional stand	62CM9UA/62CM9UE: ST6202S 72CM9UA/72CM9UE: ST7202S		

- Design and specifications are subject to change without notice.
- Never service or remodel the TV by yourself. It may expose you to a fire hazard or dangerous voltages.

# TOSHIBA CORPORATION

YC/P